

# CATÁLOGO GERAL

# CATÁLOGO GENERAL

MOBILIÁRIO E TECNOLOGIA PARA  
AMBIENTES DE APRENDIZAGEM

MOBILIARIO Y TECNOLOGÍA PARA  
AMBIENTES DE APRENDIZAJE



The future is education.



A NAUTILUS DESENVOLVE SOLUÇÕES INOVADORAS E DE ELEVADA QUALIDADE EM MOBILIÁRIO ESCOLAR E EM TECNOLOGIAS DE APRENDIZAGEM. A NAUTILUS POSSUI TRÊS UNIDADES INDUSTRIAIS E AS SUAS REDES DE CLIENTES E DE DISTRIBUIÇÃO GARANTEM A SUA PRESENÇA EM MAIS DE 20 PAÍSES. HOJE, A NAUTILUS É A EMPRESA LÍDER EM PORTUGAL E UMA REFERÊNCIA NO MERCADO EUROPEU.

NAUTILUS DESARROLLA SOLUCIONES INNOVADORAS Y DE CALIDAD PARA EQUIPO ESCOLAR Y TECNOLOGÍAS PARA EL APRENDIZAJE. NAUTILUS TIENE TRES UNIDADES INDUSTRIALES UBICADAS EN EL SUR DE EUROPA Y SUS REDES DE CLIENTES Y DISTRIBUCIÓN ASEGURAN SU PRESENCIA EN MÁS DE 20 PAÍSES. HOY NAUTILUS ES LA COMPAÑÍA LÍDER EN PORTUGAL Y UNA REFERENCIA EN EL MERCADO EUROPEO.

## MARCENARIA CARPINTERÍA

NESTA ÁREA DE PRODUÇÃO PREVALECE O TRABALHO MANUAL SOBRE O INDUSTRIAL. AQUI, A EMPRESA ALICERÇA A SUA ATIVIDADE COM O SABER ACUMULADO, A TRADIÇÃO E O GENEROSO CAPITAL HUMANO, NUMA REGIÃO COM FORTES LAÇOS COM A PRODUÇÃO DE MOBILIÁRIO E VOLTADA PARA O FUTURO. CADA PEÇA PASSA POR MÃOS EXPERIENTES, SEGUINDO PARA UMA LINHA DE ACABAMENTO QUE PERMITE UMA QUALIDADE SUPERIOR.

EN ESTAS INSTALACIONES PREVALECE EL TRABAJO MANUAL SOBRE EL INDUSTRIAL. EN ESTE CASO, LA EMPRESA BASA SU ACTIVIDAD EN EL CONOCIMIENTO ACUMULADO, LA TRADICIÓN Y EL CAPITAL HUMANO GENEROSO, EN UNA REGIÓN CON FUERTES LAZOS CON LA PRODUCCIÓN DE MUEBLES. CADA PIEZA, TRABAJADA POR MANOS EXPERIMENTADAS, PASA POR UN PROCESO DE ACABADO QUE PERMITE UNA CALIDAD SUPERIOR.

## SERRALHARIA CERRAJERÍA

NESTA UNIDADE DESENVOLVEM-SE AS ATIVIDADES DE SERRALHARIA. AS INSTALAÇÕES POSSUEM AINDA UMA ÁREA ESPECIALIZADA PARA A MONTAGEM DE PRODUTOS TECNOLÓGICOS. ESTA É AINDA A SEDE DA EMPRESA, ONDE SE LOCALIZA A ÁREA ADMINISTRATIVA, O NÚCLEO DE INVESTIGAÇÃO TECNOLÓGICA E UM SHOWROOM DE 700 M2.

EN ESTA UNIDAD SE DESARROLLAN ACTIVIDADES DE CERRAJERÍA. LAS INSTALACIONES CUENTAN CON UN ÁREA ESPECIALIZADA EN EL MONTAJE DE PRODUCTOS TECNOLÓGICOS. ES TAMBIÉN LA SEDE DE LA EMPRESA, DONDE SE ENCUENTRAN LAS OFICINAS ADMINISTRATIVAS, ASÍ COMO EL CENTRO DE INVESTIGACIÓN TECNOLÓGICA Y UNA SALA DE EXHIBICIÓN CON 700M<sup>2</sup>.

## INJEÇÃO DE POLÍMEROS INYECCIÓN DE POLÍMEROS

ESTA UNIDADE PROCEDE À TRANSFORMAÇÃO DE COMPONENTES EM TUBO E, SOBRETUDO, EM CHAPA. POSSUI TAMBÉM UMA LINHA DE PINTURA EPOXY. NESTA UNIDADE ESTÁ AINDA INSTALADA A LINHA DE INJEÇÃO DE POLIPROPILENO, ASSISTIDA POR GÁS, TOTALMENTE AUTOMATIZADA DE FORMA A PERMITIR A PRODUÇÃO EM MASSA DE FORMA EFICIENTE. TEM CAPACIDADE PARA PRODUZIR 2.000 CADEIRAS ERGOS POR DIA. A MONTAGEM E A EXPEDIÇÃO DOS PRODUTOS ACABADOS REALIZA-SE A PARTIR DESTA UNIDADE.

EN ESTAS INSTALACIONES SE TRANSFORMAN LOS COMPONENTES EN TUBO DE ACERO Y EN CHAPA METÁLICA. HAY TAMBIÉN UNA LÍNEA DE PINTURA DE POLVO EPOXI. EN ESTA UNIDAD ESTÁ TAMBIÉN INSTALADA UNA LÍNEA DE INYECCIÓN DE POLIPROPILENO, ASISTIDA POR GAS, TOTALMENTE AUTOMATIZADO PARA PERMITIR LA PRODUCCIÓN EN MASA DE FORMA EFICIENTE. TIENE CAPACIDAD PARA PRODUCIR 2.000 SILLAS ERGOS POR DÍA. EL MONTAJE Y EL ENVÍO DE LOS PRODUCTOS TERMINADOS SE LLEVA A CABO DESDE ESTA UNIDAD.

## A NAUTILUS VISA AJUDAR A ESCOLA NA TAREFA DE EDUCAR OS LÍDERES DE AMANHÃ.

NAUTILUS SE  
PROPONE A AYUDAR  
A LA ESCUELA EN LA  
TAREA DE EDUCAR  
A LOS LÍDERES DEL  
MAÑANA.

1996... / START HERE



20 ANOS  
DE PESQUISA  
& INOVAÇÃO

20 AÑOS DE  
INVESTIGACIÓN  
& INNOVACIÓN

COM O OBJETIVO CONTÍNUO DE CRIAÇÃO E DE DESENVOLVIMENTO DE NOVOS PRODUTOS E DE SOLUÇÕES PERSONALIZADAS, A NAUTILUS TEM UM CENTRO DE PESQUISA E DESENVOLVIMENTO TECNOLÓGICO DE PRODUTO, A PARTIR DO QUAL TRABALHA EM ESTREITA RELAÇÃO COM SEUS CLIENTES.

CON EL OBJETIVO CONTINUO DE CREAR Y DESARROLLAR NUEVOS PRODUCTOS Y SOLUCIONES PERSONALIZADAS, NAUTILUS TIENE UN CENTRO DE INVESTIGACIÓN Y DESARROLLO TECNOLÓGICO DE PRODUCTO, EN EL CUAL TRABAJA EN ESTRECHA RELACIÓN CON SUS CLIENTES.

EMPRESA LÍDER  
NA PRODUÇÃO DE  
MOBILIÁRIO ESCOLAR,  
A NAUTILUS OFERECE  
TODAS AS SOLUÇÕES  
PARA O EQUIPAMENTO  
DE UMA SALA DE  
AULA.

EMPRESA LÍDER EN  
LA PRODUCCIÓN DE  
MOBILIARIO ESCOLAR,  
NAUTILUS OFRECE  
SOLUCIONES PARA  
TODOS LOS EQUIPOS  
EN UN AULA.

## INDEX

**01** PRÉ-ESCOLAR PREESCOLAR P.10

**02** CADEIRAS SILLAS P.22

**03** MESAS MESAS P.36

**04** ARMÁRIOS ARMARIOS P.46

**05** LABORATÓRIO LABORATORIO P.54

**06** BIBLIOTECA BIBLIOTECA P.58

**07** AUDITÓRIO AUDITORIO P.66

**08** COLETIVIDADES COLECTIVIDADES P.72

**09** DIVERSOS DIVERSOS P.82

**10** TECNOLOGIA TECNOLOGÍA P.86

REFERÊNCIAS REFERENCIAS P.108

ACABAMENTOS ACABADOS P.120

PROJETOS PROYECTOS P.124

PRÉ-ESCOLAR  
PREESCOLAR



# CASA DE BONECAS CASA DE MUÑECAS

UM MUNDO DOS PEQUENINOS  
UN MUNDO DE PEQUEÑOS



CB.KQ

CB.KQ  
Kit quarto  
Kit habitación

CB.KB  
Kit biblioteca  
Kit biblioteca

CB.KC  
Kit cozinha  
Kit cocina



CB.KB



CB.KC

# CRECHE GUARDERÍA

ESPAÇOS DIVERTIDOS E COLORIDOS  
ESPACIOS DIVERTIDOS Y COLORIDOS



PF 04  
Puff quadrado  
Puff cuadrado

PF 03  
Puff pêra  
Puff pera

TA 15  
Tapete  
Colchoneta

SP 02  
Catre empilhável  
Catre apilable

BM 01  
Banca de muda  
Armario cambiador

PF 01  
Puff redondo  
Puff redondo

BE 01  
Berço  
Cuna





## Q3 | EXPO SA

### MOBILIÁRIO EM MADEIRA PARA OS MAIS PEQUENOS MUEBLES DE MADERA PARA LOS MÁS PEQUEÑOS

ESTRUTURA EM TUBO DE AÇO (Q3). SUPERFÍCIE EM AGLOMERADO DE MADEIRA. REVESTIDO A TERMOLAMINADO. ORLAS EM MADEIRA MACIÇA.  
ESTRUCTURA EN TUBO DE ACERO (Q3). SUPERFICIE EN AGLOMERADO DE MADERA. REVESTIDO DE LAMINADO. CANTEADO EN MADEIRA MACIZA.



AGJIS

AFJIS

NM 11

AAJIS

FB

FD

FF

FE

AA 1



Q3 | FB  
Mesa dupla  
Mesa doble

Q3 | FD  
Mesa trapezoidal  
Mesa trapezoidal

Q3 | FE  
Mesa circular  
Mesa circular

Q3 | FF  
Mesa semi-circular  
Mesa semicircular

Q3 | AA 1  
Cadeira em laminado  
Silla en laminado

Q3 | NM 11  
Armário com tabuleiros  
Armario con bandejas

EXPO SA | AFJIS  
Armário fechado  
Armario cerrado

EXPO SA | AGJIS  
Armário com gavetas  
Armario con cajones

EXPO SA | AAJIS  
Armário aberto  
Armario abierto

# EXPO SA

MOBILIÁRIO EM MADEIRA PARA OS MAIS PEQUENOS  
MUEBLES DE MADERA PARA LOS MÁS PEQUEÑOS

ESTRUTURA EM MADEIRA MACIÇA. SUPERFÍCIE EM AGLOMERADO DE MADEIRA. REVESTIDO A TERMOLAMINADO.  
ESTRUTURA EN MADERA MACIZA. SUPERFÍCIE EN AGLOMERADO DE MADERA. REVESTIDO DE LAMINADO.

EPSAM  
Mesa em madeira  
Mesa en madera

EPSAC  
Cadeira em madeira  
Silla en madera

EPSAB  
Banco em madeira  
Banco en madera



EPSAM



EPSAC



EPSAB

# ERGOS

BOA POSTURA DESDE A PRIMEIRA INFÂNCIA  
BUENA POSTURA DESDE LA PRIMERA INFANCIA

LINHA EM POLIPROPILENO DE DUPLA PAREDE, OBTIDA POR INJEÇÃO ASSISTIDA POR GÁS.  
LÍNEA EN POLIPROPILENO DE PARED DOBLE OBTENIDA POR INYECCIÓN ASISTIDA POR GAS.



LN 12

T1

T2

NM 03

ERGMI

ERGOS



LAVÁVEL  
LAVABLE



LEVE  
LIGERO



DESMONTÁVEL  
DESMONTABLE



ANTIBACTERIANA  
ANTIBACTERIANO



GARANTIA  
GARANTÍA

LN 12  
Armário com tabuleiros  
Armario con bandejas

T1 | T2  
Tabuleiro em polipropileno  
Bandeja en polipropileno

ERGMI  
Mesa em polipropileno  
Mesa en polipropileno

ERGOS  
Cadeira em polipropileno  
Silla en polipropileno

NM 03  
Armário individual com tabuleiros  
Armario individual con bandejas

BERG  
Banco com tabuleiros  
Banco con bandejas



BERG

CADEIRAS  
SILLAS

012



# ERGOS

À PROVA DE MIÚDOS... E GRAÚDOS  
A PRUEBA DE NIÑOS... Y MAYORES

ESTRUTURA EM POLIPROPILENO DE DUPLA PAREDE, OBTIDA POR INJEÇÃO ASSISTIDA POR GÁS.  
ESTRUCTURA EN POLIPROPILENO DE PARED DOBLE, OBTENIDA POR INYECCIÓN ASISTIDA POR GAS.

**RESISTENTE  
LAVÁVEL  
ERGONÓMICA  
DURÁVEL  
PRÁTICA  
SEGURA**

**RESISTENTE  
LAVABLE  
ERGONÓMICA  
DURABLE  
PRÁCTICA  
SEGURA**



Integralmente produzidas em polipropileno de dupla parede, as cadeiras ERGOS foram testadas e certificadas pelo laboratório FIRA INTERNACIONAL, uma das maiores autoridades em testes de mobiliário a nível mundial. Adequadas para salas de aula, refeitórios e para uso exterior, estão disponíveis em 7 tamanhos desde o pré-escolar até à idade adulta. As cadeiras ERGOS cumprem com a norma EN 1729 parte 1 e 2 (standard europeu para dimensões, resistência e estabilidade).

Totalmente producidas en polipropileno de doble pared, las sillas ERGOS fueron probadas y certificadas por el laboratorio FIRA INTERNACIONAL, una autoridad líder en pruebas de muebles en todo el mundo. Adecuadas para aulas, comedores y uso en el exterior, están disponibles en 7 tallas, desde preescolar hasta la edad adulta. Las sillas ERGOS cumplen la norma EN 1729 parte 1 y 2 (estándar europeo para el tamaño, la resistencia y la estabilidad).



# ERGOS

À PROVA DE MIÚDOS... E GRAÚDOS  
A PRUEBA DE NIÑOS... Y MAIORES

ESTRUTURA EM POLIPROPILENO DE DUPLA PAREDE, OBTIDA POR INJEÇÃO ASSISTIDA POR GÁS.  
ESTRUCTURA EN POLIPROPILENO DE PARED DOBLE, OBTENIDA POR INYECCIÓN ASISTIDA POR GAS.

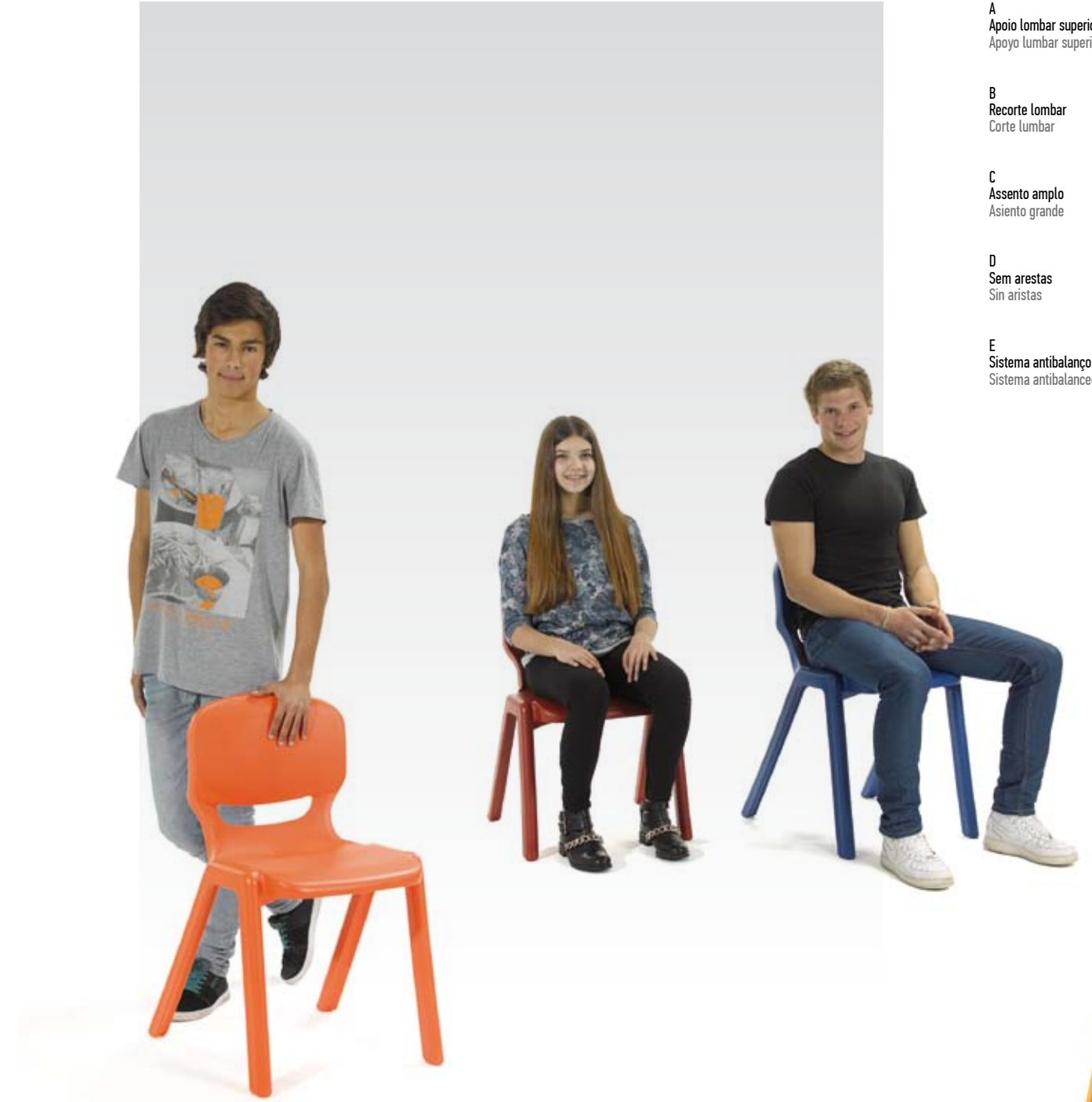

- A**  
Apoio lombar superior  
Apoyo lumbar superior
- B**  
Recorte lombar  
Corte lumbar
- C**  
Assento amplo  
Asiento grande
- D**  
Sem arestas  
Sin aristas
- E**  
Sistema antibalanço  
Sistema antibalaneo



-  **POSTURA CORRETA**  
POSTURA CORRECTA
-  **DURÁVEL**  
RESISTENTE
-  **LAVÁVEL**  
LAVABLE
-  **LEVE**  
LIGERO
-  **PERSONALIZÁVEL**  
PERSONALIZABLE
-  **EMPILHÁVEL**  
APILABLE
-  **RECICLÁVEL**  
RECICLABLE
-  **ANTIBACTERIANA**  
ANTIBACTERIANO
-  **PROTEÇÃO UV**  
PROTECCIÓN UV
-  **GARANTIA**  
GARANTÍA

[  Cores personalizáveis mediante encomendas mínimas  
Colores personalizados bajo pedido mínimo ]

[  Sistema de ligação integrado (pág.69)  
Sistema de conexión integrado (pág.69) ]



# MAIS

UMA ESCOLHA ECOLÓGICA  
UNA OPCIÓN ECOLÓGICA

ESTRUTURA EM TUBO DE AÇO. ASSENTO E ENCOSTO EM POLIPROPILENO. TERMINAIS EXTERIORES CONTRA CORROSÃO  
ESTRUCTURA EN TUBO DE ACERO. ASIENTO Y RESPALDO EN POLIPROPILENO. TERMINALES EXTERIORES CONTRA LA CORROSIÓN.



GARANTIA  
GARANTÍA



MAIS Ah 21

MAIS Ah 23

**MAIS AA**  
Cadeira com assento e encosto em PP  
Silla con asiento e respaldo en PP

**MAIS UNI AA**  
Cadeira cantilever invertido  
Silla cantilever inversa

**MAIS AC**  
Cadeira com palmatória  
Silla con pala

**MAIS Ah 21**  
Cadeira alta  
Silla alta

**MAIS Ah 23**  
Cadeira giratória  
Silla giratoria



15 cores disponíveis  
15 colores disponibles



MAIS AA



MAIS UNI AA



MAIS AC

# DUAL\_STEP

## ADAPTABILIDADE E ERGONOMIA ADAPTABILIDAD E ERGONOMÍA

ESTRUTURA EM TUBO DE AÇO. ASSENTO E ENCOSTO EM CONTRAPLACADO, FOLHEADO A MADEIRA OU REVESTIDO A TERMOLAMINADO.  
ESTRUCTURA EN TUBO DE ACERO. ASIENTO Y RESPALDO EN CONTRACHAPADO, CHAPADO EN HAYA O REVESTIDO DE LAMINADO.



**A**  
Posição de equilíbrio natural com o tronco alinhado verticalmente.

Posición de equilibrio natural con el tronco alineado verticalmente.

**B**  
Espaço entre a face posterior da perna e o assento eliminando pressões na face inferior das coxas.

Espacio entre la parte posterior de la pierna y el asiento eliminando la presión en los muslos inferiores.

**C**  
Altura do assento igual à altura poplíteia evitando a dormência (joelhos a 90°).

La altura del asiento igual a la altura poplíteia evitando el entumecimiento (rodillas a 90°).

**D**  
Pés perfeitamente apoiados no chão.

Pies perfectamente apoyados en el suelo.

Por meio de um mecanismo único e inovador, a cadeira permite uma regulação contínua e simultânea, num só movimento, da altura e profundidade do assento e da altura do encosto. O manipulo, discreto e inamovível, permite bloquear todo o sistema e assim fixar a cadeira na posição desejada.

A través de un mecanismo único e innovador, la silla permite una regulación continua y simultánea en un solo movimiento, de la altura y de la profundidad del asiento y la altura del respaldo. El botón discreto e inamovible permite bloquear todo el sistema y fijar así la silla a la posición deseada.

ERGONÓMICA  
ERGONÓMICA

EMPILHÁVEL  
APILABLE

SEGURA  
SEGURA

EN  
NORMA EUROPEIA  
NORMA EUROPEA

VERSÁTIL  
VERSÁTIL

DURÁVEL  
DURABLE



Premiada em | Premiada en  
18th Annual Applied Ergonomics  
Conference 2015 (Nashville, USA)

**U. PORTO**

Desenvolvida em parceria com o  
Design Studio da FEUP

Desarrollada en colaboración con  
el Design Studio de FEUP



Q3

TRADICIONAL E ROBUSTA  
TRADICIONAL Y ROBUSTO

ESTRUTURA EM TUBO DE AÇO. ASSENTO E ENCOSTO EM CONTRAPLACADO. FOLHEADO A MADEIRA OU REVESTIDO A TERMOLAMINADO.  
ESTRUCTURA EN TUBO DE ACERO. ASIENTO Y RESPALDO EN CONTRACHAPADO. CHAPADO EN HAYA O REVESTIDO DE LAMINADO.



Aa 0



Ah 21

Ah 23

Aa 0  
Cadeira em madeira  
Silla en madera

Aa 1  
Cadeira em termolaminado  
Silla en laminado

Ah 01  
Banco ajustável em altura  
Banco regulable en altura

Ah 02  
Banco ajustável em altura  
Banco regulable en altura

Ah 21  
Cadeira giratória  
Silla giratoria

Ah 23  
Cadeira giratória  
Silla giratoria



Aa 1



Ah 01



Ah 02

# CMM | UNI | UNI\_STEP

DESIGN AO SERVIÇO DA EDUCAÇÃO  
DISEÑO AL SERVICIO DE LA EDUCACIÓN

ESTRUTURA EM TUBO DE AÇO. ASSENTO E ENCOSTO EM CONTRAPLACADO. FOLHEADO A FAIA OU REVESTIDO A TERMOLAMINADO.  
ESTRUCTURA EN TUBO DE ACERO. ASIENTO Y RESPALDO EN CONTRACHAPADO. CHAPADO EN HAYA O REVESTIDO DE LAMINADO.



CMM | Ma.C  
Cadeira com estrutura de aço  
Silla con estructura de acero

UNI | UNI AA  
Cadeira cantilever invertido  
Silla cantilever inversa

UNI\_STEP | URE AA  
Cadeira regulável em altura  
Silla regulable en altura



Ma.C



UNI AA



URE AA

MESAS  
MESAS

ORB

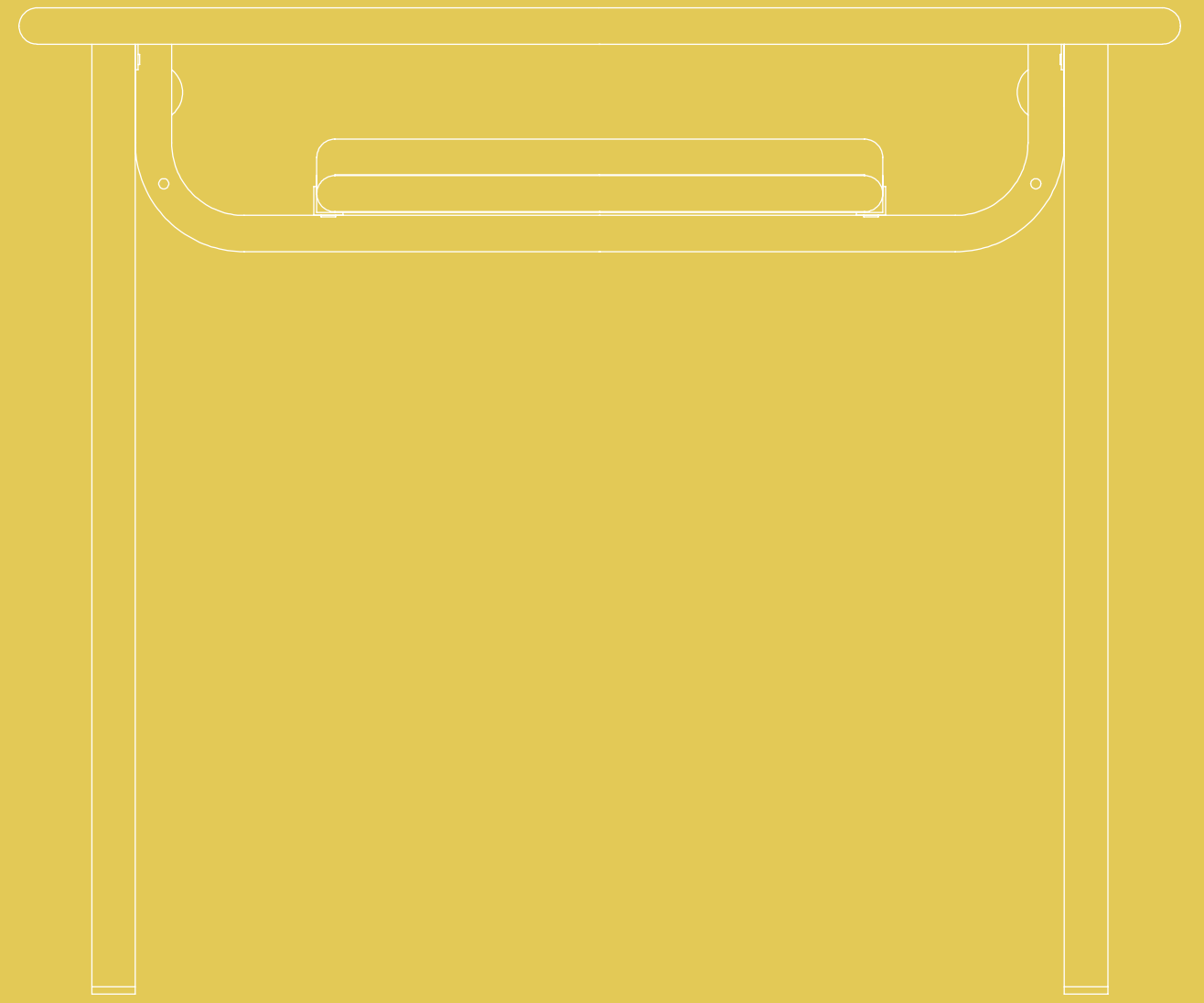

# MAIS | ONE

PARA UMA APRENDIZAGEM COLABORATIVA  
PARA EL APRENDIZAJE COLABORATIVO

ESTRUTURA EM TUBO DE AÇO. TAMPO EM POLIPROPILENO (MAIS), TAMPO EM COMPACMEL® (ONE).  
ESTRUCTURA EN TUBO DE ACERO. ENCIMERA EN POLIPROPILENO (MAIS), ENCIMERA EN COMPACMEL® (ONE).



MAIS UNI FA



MAIS FAD

MAIS FA



ONE R

- **TAMPO**  
Retangular ou trapezoidal  
ENCIMERA  
Trapezoidal o rectangular
- **MOBILIDADE**  
Rodizios embutidos  
MOVILIDAD  
Rodillos incorporados
- **PRATELEIRA**  
Para arrumação de cadernos e livros  
BANDEJA  
Para el almacenamiento de cuadernos y libros
- **ERGONOMIA**  
Tampo inclinável e altura regulável para total ergonomia.  
ERGONOMÍA  
Encimera inclinable y regulación en altura para una ergonomía completa.
- **SUORTE PARA TABLET**  
Para uma aprendizagem colaborativa  
SOPORTE PARA TABLET  
Para el aprendizaje cooperativo

A mesa One é regulável em altura, de forma a acompanhar a altura selecionada para a cadeira DUAL\_STEP, ajustando-se perfeitamente à estatura de cada aluno.

La mesa ONE es ajustable en altura, con el fin de adecuar la altura seleccionada para la silla DUAL\_STEP, adaptándose perfectamente a la talla de cada alumno.

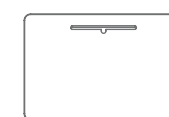

Retangular  
Rectangular

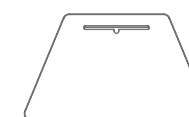

Trapezoidal  
Trapezoidal

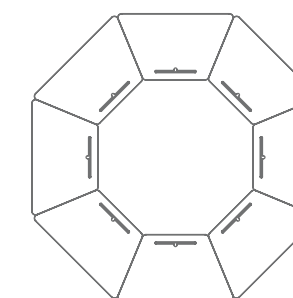

Círculo de 8 mesas  
Círculo de 8 mesas

MAIS FA  
Mesa individual  
Mesa individual

MAIS UNI FA  
Mesa cantilever  
Mesa cantilever

MAIS FAD  
Mesa desmontável  
Mesa desmontable

ONE R  
Mesa com tampo inclinável e regulação em altura  
Mesa con encimera inclinable y ajustable en altura

# DESK21

VERSATILIDADE E ERGONOMIA  
VERSATILIDAD Y ERGONOMÍA

ESTRUTURA EM TUBO DE AÇO. TAMPO EM COMPACMEL®.  
ESTRUCTURA EN TUBO DE ACERO. ENCIMERA EN COMPACMEL®.



DESK21 | DESK21 R

DESK21 STR

DESK21 STP

DESK21 STC



DESK21 A | DESK21AR

DESK21  
Mesa fixa  
Mesa fija

DESK21 R  
Mesa regulável  
Mesa ajustable

DESK21 A  
Mesa alta  
Mesa alta

DESK21 AR  
Mesa alta regulável  
Mesa alta ajustable

DESK21 STR  
Subtampo em rede metálica  
Bandeja en rede metálica

DESK21 STP  
Subtampo com Ergos tray  
Bandeja con Ergos tray

DESK21 STC  
Subtampo em chapa perfurada  
Bandeja en chapa perforada

  
DURÁVEL  
DURABLE

  
REGULÁVEL  
REGULABLE

  
AMBIDEXTRA  
AMBIDESTRA

  
VERSÁTIL  
VERSÁTIL

  
DESMONTÁVEL  
DESMONTABLE

EN  
NORMA EUROPEIA  
NORMA EUROPEA

TRADICIONAL E ROBUSTA  
TRADICIONAL Y ROBUSTO

ESTRUTURA EM TUBO DE AÇO. TAMPO EM AGLOMERADO DE MADEIRA. PÉS EM POLIAMIDA.  
ESTRUCTURA EN TUBO DE ACERO. ENCIMERA EN AGLOMERADO DE MADERA. PIES EN POLIAMIDA



FB im



FA



FA i



FB



HA 01



FF



FE



FC

FB im  
Mesa dupla com subtampo  
Mesa doble con bandeja

FA  
Mesa individual  
Mesa individual

FA i  
Mesa individual com subtampo  
Mesa individual con bandeja

FB  
Mesa dupla  
Mesa doble

HA 01  
Mesa de desenho  
Mesa de dibujo

FF  
Mesa semi-circular  
Mesa semicircular

FE  
Mesa circular  
Mesa circular

FC  
Mesa múltipla para refeição  
Mesa múltiple para comedor

# CMM | UNI\_STEP | UNI

DESIGN AO SERVIÇO DA EDUCAÇÃO  
DISEÑO AL SERVICIO DE LA EDUCACIÓN

ESTRUTURA EM TUBO E CHAPA DE AÇO. TAMPO E SUBTAMPO EM AGLOMERADO DE MADEIRA. REVESTIMENTO A TERMOLAMINADO. ORLAS EM MADEIRA MACIÇA.  
ESTRUCTURA EN CHAPA Y TUBO DE ACERO. ENCIMERA Y BANDEJA EN AGLOMERADO DE MADEIRA. REVESTIDO DE LAMINADO. CANTEADO EN MADERA MACIZA.



MA.FB | MA.FA



MA.MAT | MA.MAT.I



URE.FB



URI.FA



UNI.FA | UNI.FB



UNI.FH.01



UNI.FD

CMM | MA.FB  
Mesa dupla sem subtampo  
Mesa doble sin bandeja

CMM | MA.FA  
Mesa individual sem subtampo  
Mesa individual sin bandeja

CMM | MA.MAT  
Mesa dupla com tampo inclinável  
Mesa doble con encimera inclinable

CMM | MA.MAT.I  
Mesa individual com tampo inclinável  
Mesa individual con encimera inclinable

UNI\_STEP | URE.FB  
Mesa dupla regulável  
Mesa doble regulable

UNI\_STEP | URI.FA  
Mesa individual com tampo inclinável  
Mesa individual con encimera inclinable

UNI | UNI.FA  
Mesa individual cantilever  
Mesa individual cantilever

UNI | UNI.FB  
Mesa dupla cantilever  
Mesa doble cantilever

UNI | UNI.FH.01  
Mesa de professor  
Mesa de profesor

UNI | UNI.FD  
Mesa trapezoidal cantilever  
Mesa trapezoidal cantilever

ARMÁRIOS  
ARMARIOS

# 04





Q3

ARMÁRIOS EM MADEIRA - ROBUSTEZ E QUALIDADE  
ARMARIOS EN MADERA - ROBUSTEZ Y CALIDAD

ESTRUTURA EM AGLOMERADO DE MADEIRA, FOLHEADA A FAIA. ENCABEÇAMENTO E RODAPÉ EM MADEIRA MACIÇA DE FAIA.  
ESTRUCTURA EN AGLOMERADO DE MADERA, CHAPADA EN HAYA. CANTOS Y ZÓCALO EN MADERA MACIZA DE HAYA.

Ma  
Armário fechado  
Armario cerrado

Mb  
Armário aberto  
Armario abierto

Nc 02  
Armário vitrine  
Armario vitrina



Q3

ARMÁRIOS EM MADEIRA - ROBUSTEZ E QUALIDADE  
ARMARIOS EN MADERA - ROBUSTEZ Y CALIDAD

ESTRUTURA EM AGLOMERADO DE MADEIRA, FOLHEADA A FAIA. ENCABEÇAMENTO E RODAPÉ EM MADEIRA MACIÇA DE FAIA.  
ESTRUCTURA EN AGLOMERADO DE MADERA. CHAPADA EN HAYA. CANTOS Y ZÓCALO EN MADERA MACIZA DE HAYA.



Mi 01  
Armário de desenhos  
Armario de dibujos

Ng 01  
Armário misto  
Armario mixto

Nm 03  
Armário com tabuleiros  
Armario con bandejas



Mi 01

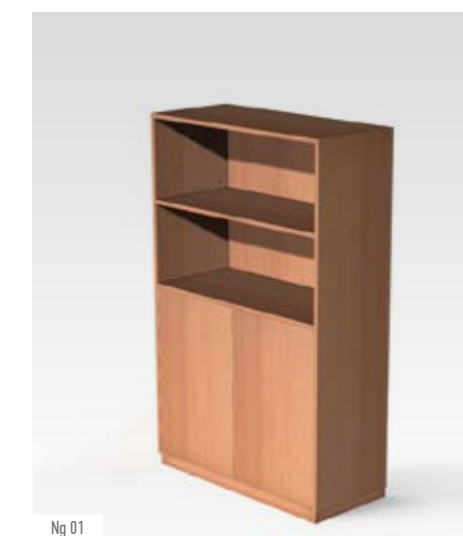

Ng 01



Nm 03

# Q3

## ARMÁRIOS METÁLICOS - COM TRATAMENTO DE ALTA QUALIDADE ARMARIOS METÁLICOS - CON TRATAMIENTO DE ALTA CALIDAD

ESTRUTURA EM CHAPA DE AÇO COM PINTURA EPOXY, COM 4 ETAPAS DE TRATAMENTO.  
ESTRUCTURA EN CHAPA DE ACERO CON PINTURA EPOXI CON 4 ETAPAS DE TRATAMIENTO.



Ld 03



Li 01



La



Lf



Ln 12



Ld 13



Lb



Ld 04 P



Pc 01



Lg

Ld 03  
Cacifo  
Casillero

Li 01  
Armário de desenhos  
Armario de dibujos

La  
Armário fechado  
Armario cerrado

Lf  
Armário vestiário  
Armario de vestuario

Ln 12  
Armário com tabuleiros  
Armario con bandejas

Ld 13  
Cacifo aberto  
Casillero abierto

Lb  
Armário aberto  
Armario abierto

Ld 04 P  
Cacifo com pés  
Casillero con pies

Pc 01  
Estante  
Estantería

Lg  
Armário misto  
Armario mixto

LABORATÓRIO  
LABORATORIO

# 03

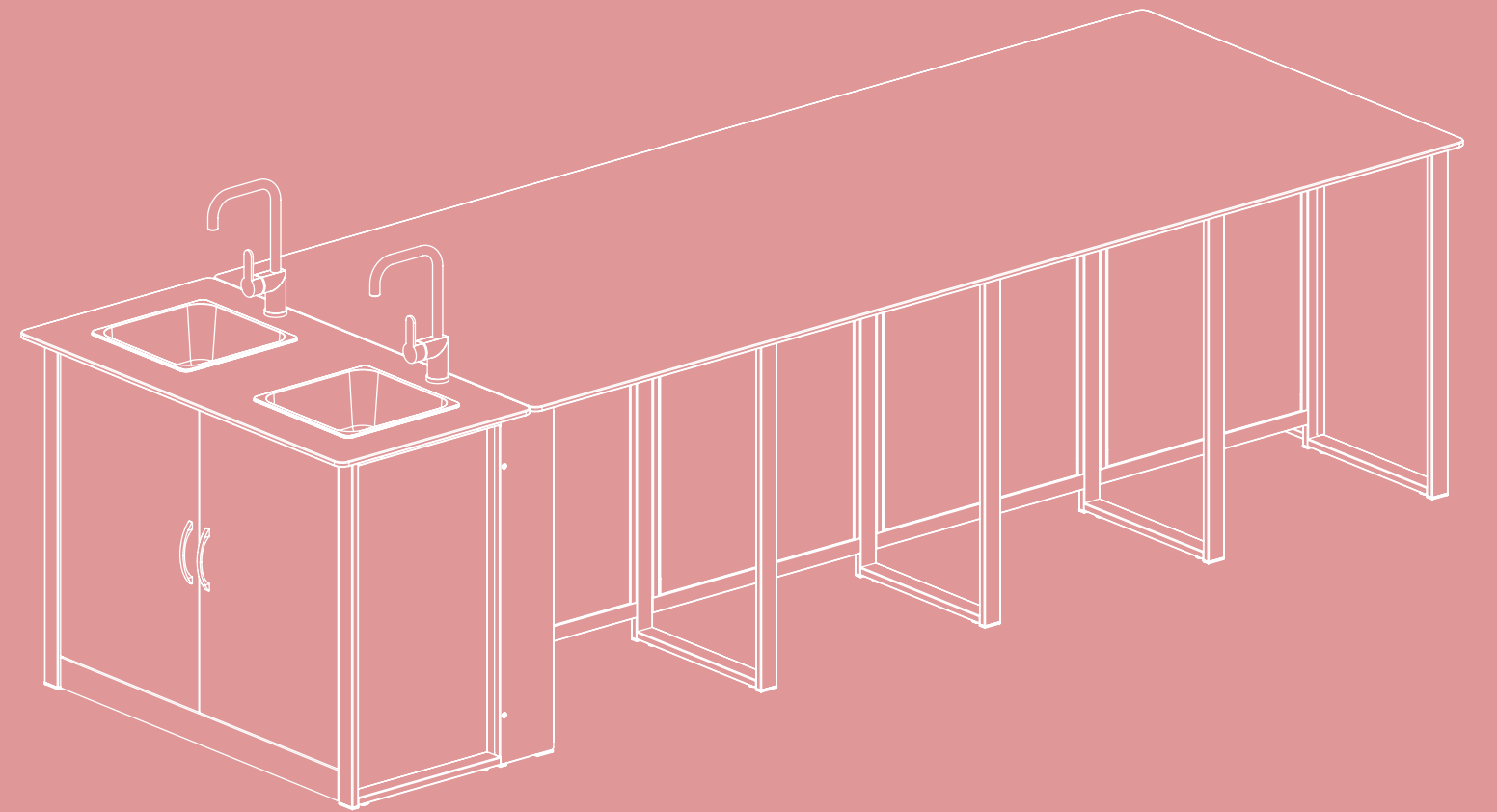

# TECHLAB

ENSINO EXPERIMENTAL  
ENSEÑANZA EXPERIMENTAL

SISTEMA MODULAR. LIGAÇÃO A ÁGUA, GÁS E ELECTRICIDADE.  
SISTEMA MODULAR. CONEXIÓN CON EL AGUA, EL GAS Y LA ELECTRICIDAD.



TL  
Techlab  
Techlab

BMC  
Techlab mobile  
Techlab mobile

T2  
Tabuleiro em polipropileno  
Bandeja en polipropileno

TE  
Espuma de acondicionamento  
Espuma de acondicionamiento



TL



T2 | TE



BMC

BIBLIOTECA  
BIBLIOTECA

# NOA

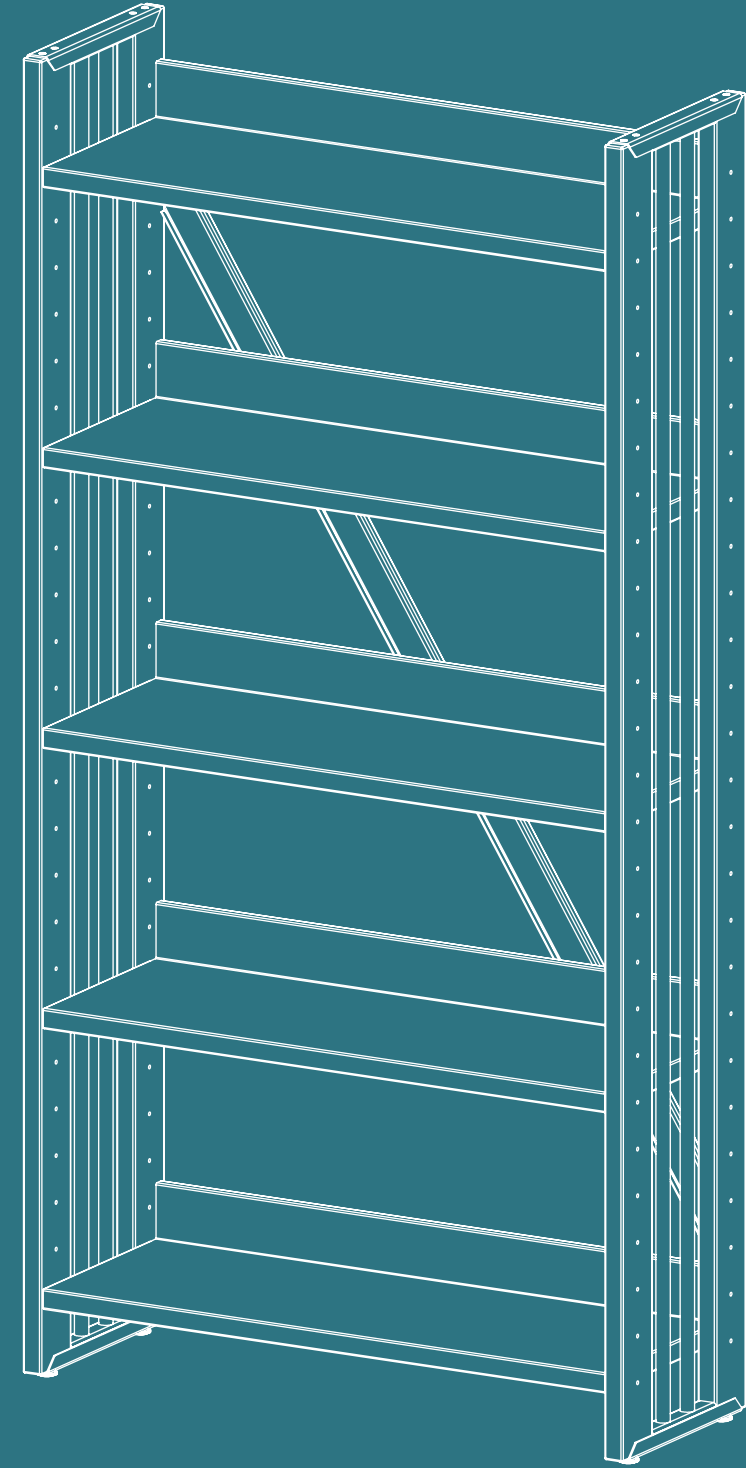

# Q2000

MADEIRA MACIÇA  
MADERA MACIZA

ESTRUTURA EM MADEIRA MACIÇA DE FAIA. VERNIZ POLIURETANO.  
ESTRUCTURA EN MADERA MACIZA DE HAYA. BARNIZ POLIURETANO.



Q2000  
Estantes  
Estantería



# BIBLUS | BIBLUS METAL

RESISTÊNCIA E DESIGN  
RESISTENCIA Y DISEÑO

ESTRUTURA MISTA EM CHAPA DE AÇO E MADEIRA MACIÇA DE FAIA | ESTRUTURA EM CHAPA DE AÇO.  
ESTRUCTURA MIXTA EN CHAPA DE ACERO Y MADERA MACIZA DE HAYA | ESTRUCTURA EN CHAPA DE ACERO.

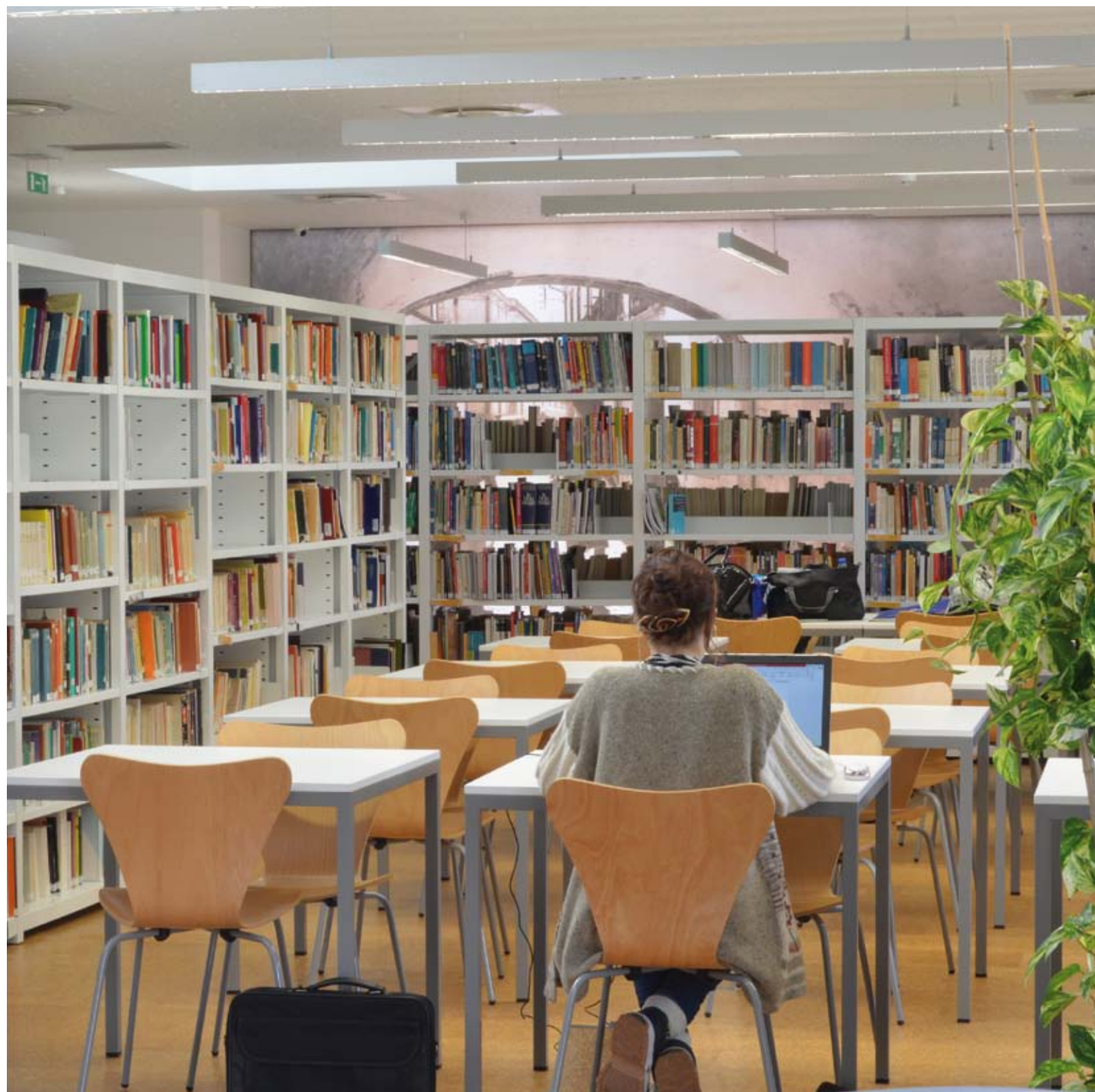

**BIBLUS**  
Estantes mistas  
Esteras mixtas

**BIBLUS METAL**  
Estantes metálicas  
Esteras metálicas





# CADEIRAS E MESAS

MADEIRA MACIÇA  
MADERA MACIZA

ESTRUTURA EM MADEIRA MACIÇA DE FAIA  
ESTRUTURA EN MADERA MACIZA DE HAYA

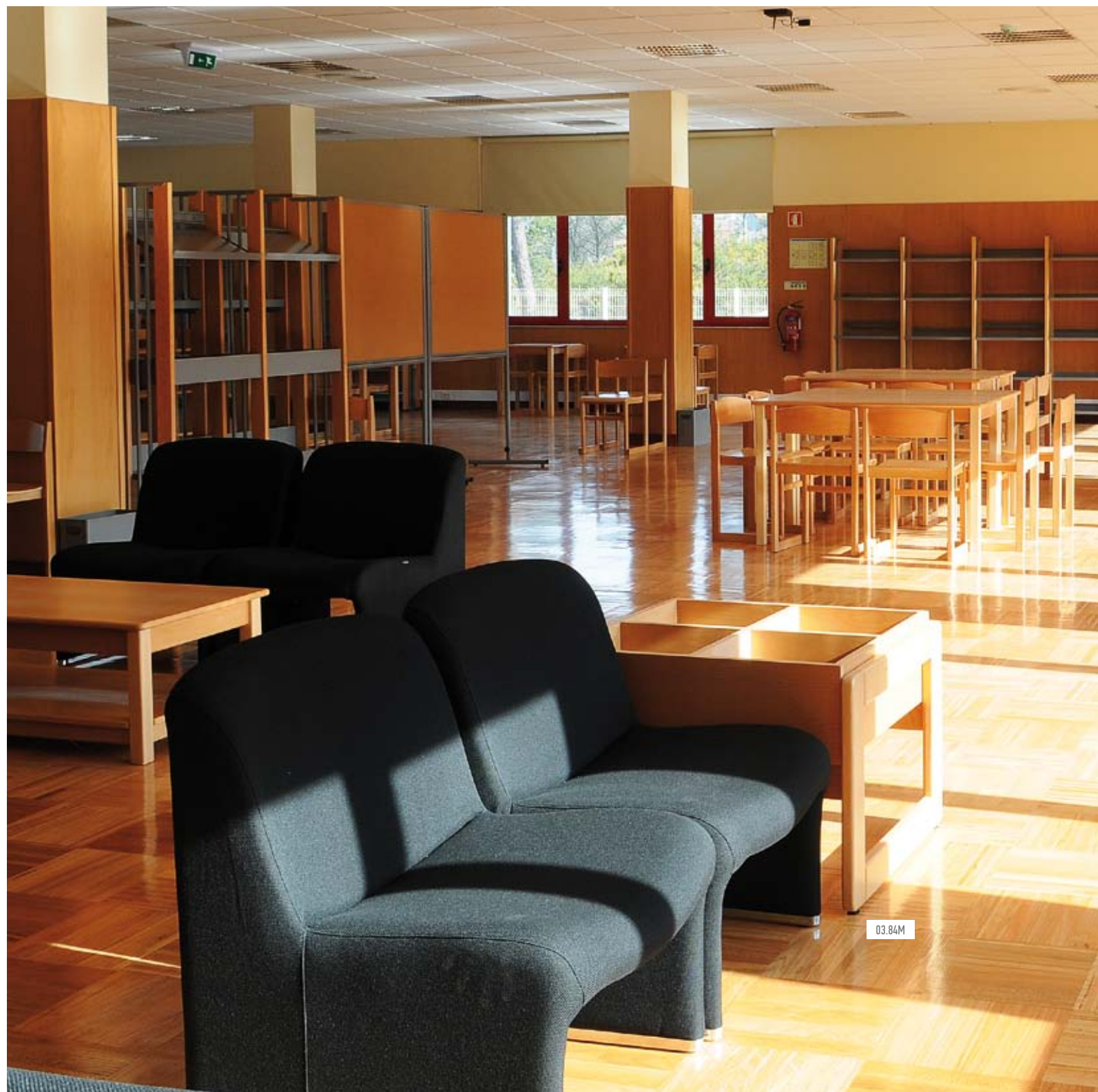

03.84M  
Contentor de álbuns  
Contenedor de álbumes

01.71M  
Mesa de apoio  
Mesa de centro

Ba  
Cadeira em madeira  
Silla en madera

Gb  
Mesa dupla  
Mesa doble

GE  
Mesa circular  
Mesa circular

CE 00.1M  
Cadeira estofada  
Silla tapizada

CC 0 NT  
Poltrona  
Sillón



AUDITÓRIO  
AUDITORIO

OW

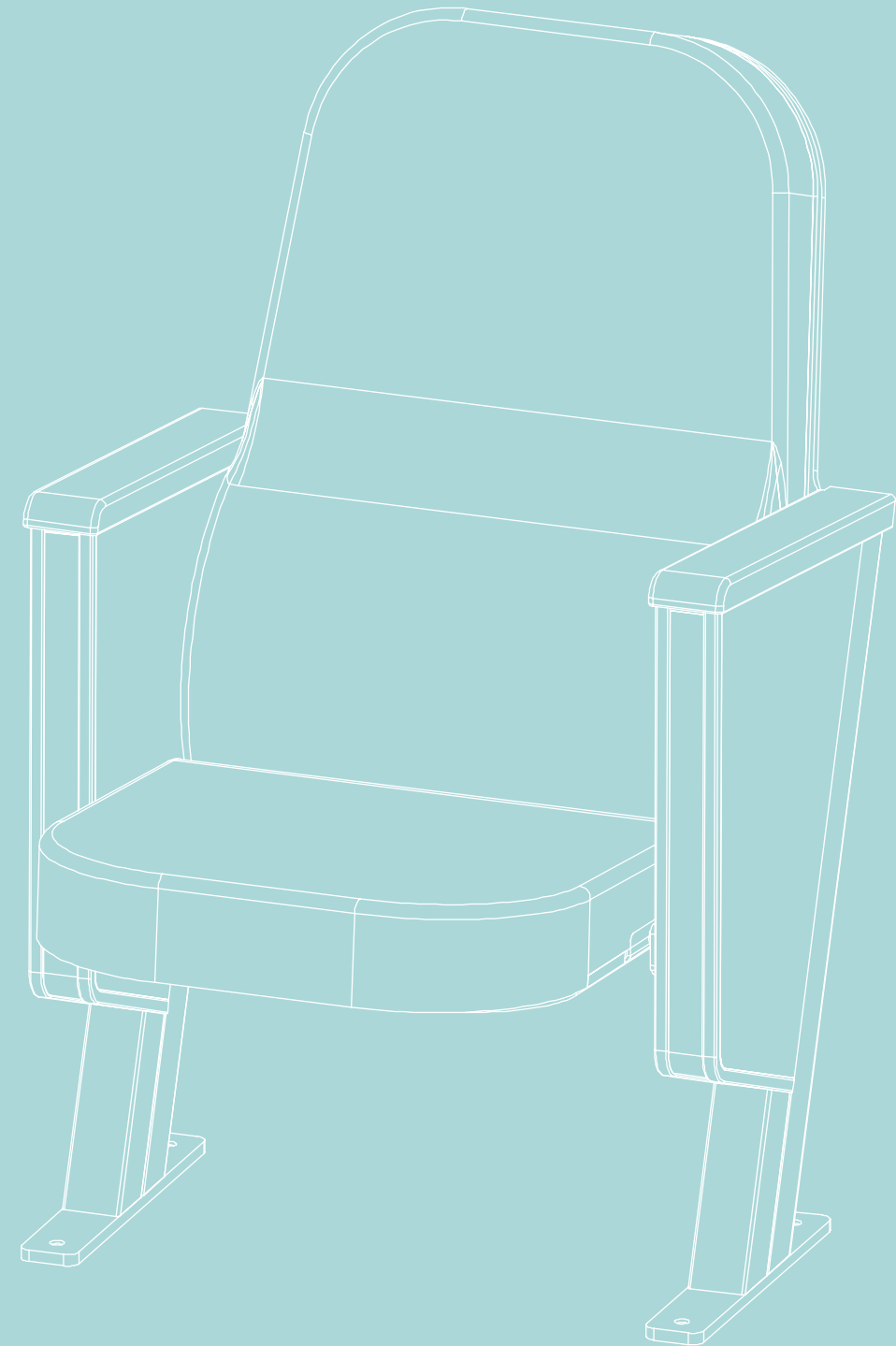

# RIA | CRUZ | LISBOA | LISBOA II | ERGOS BIG

POLTRONAS E CADEIRAS  
BUTACAS Y SILLAS

ASSENTO E ENCOSTO COM ESPUMA DE ALTA DENSIDADE. REVESTIMENTOS A TECIDO OU PELE SINTÉTICA.  
ASIENTO E RESPALDO CON ESPUMA DE ALTA DENSIDAD. REVESTIMENTOS DE TEJIDO O PIEL SINTÉTICA.

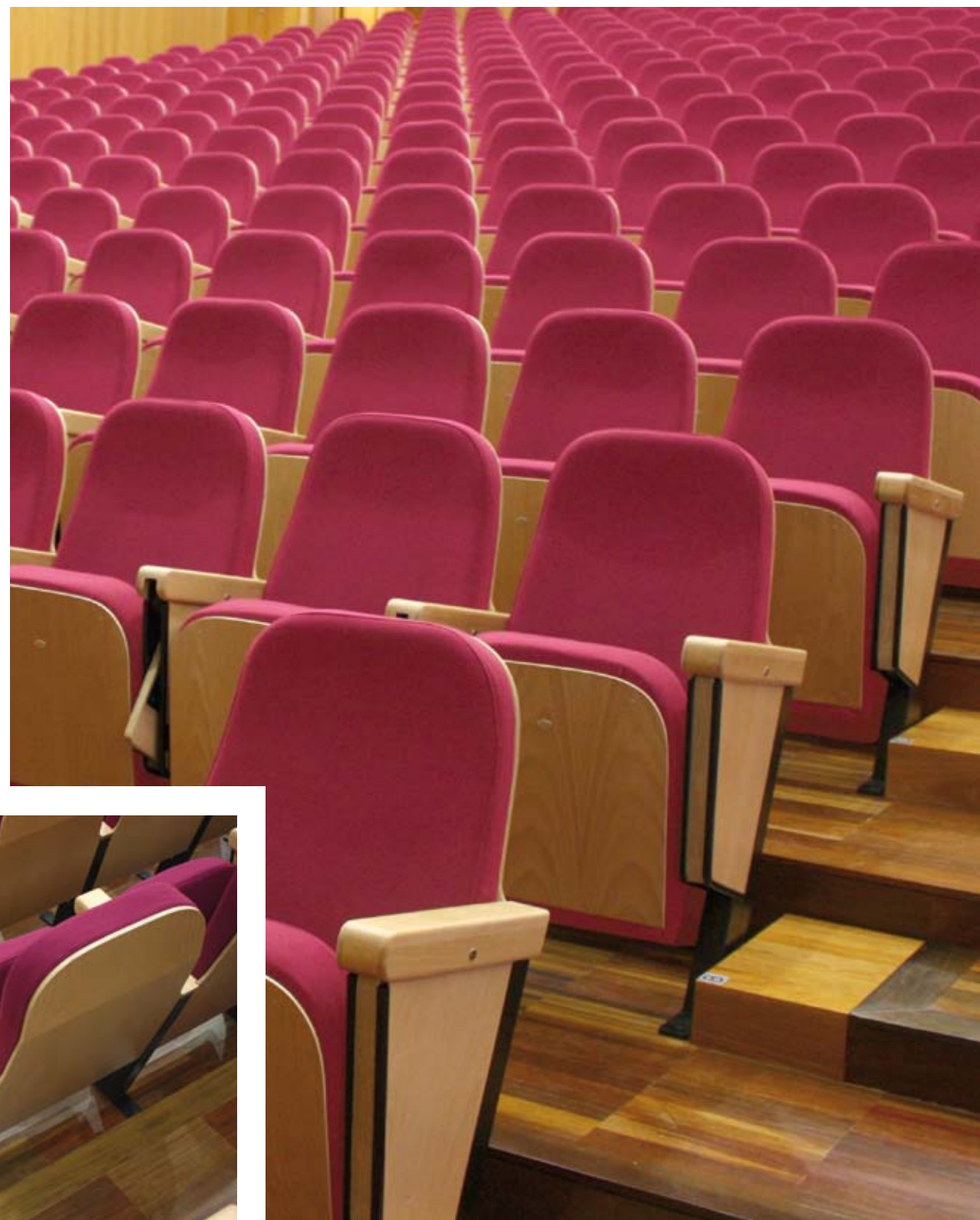

RIA



ERGOS LG



RIA  
Poltrona  
Butaca

CRUZ  
Poltrona  
Butaca

LISBOA  
Poltrona  
Butaca

LISBOA II  
Poltrona  
Butaca

ERGOS LG  
Cadeira para auditório  
Silla para auditorio



CRUZ



LISBOA



LISBOA II

# RETA | SERIES 7

ANFITEATRO  
ANFITEATRO

CASCO EM CONTRAPLACADO DE MADEIRA, FOLHEADO A FAIA.  
ASIENYO Y RESPALDO EN CONTRACHAPADO DE MADERA, CHAPADO EN HAYA.



PES.D



PES



PES  
Bancada de anfiteatro  
Pupitre para anfiteatro

PES.D  
Bancada com tampo deslizante  
Pupitre con encimera deslizante

RETA.A  
Cadeira para auditório  
Silla para auditorio

AJS7A  
Cadeira para auditório  
Silla para auditorio

MAIS VIGA  
Cadeira para auditório em polipropileno  
Silla para auditorio en polipropileno



MAIS VIGA



RETA.A



AJS7A

COLETIVIDADES  
COLECTIVIDADES

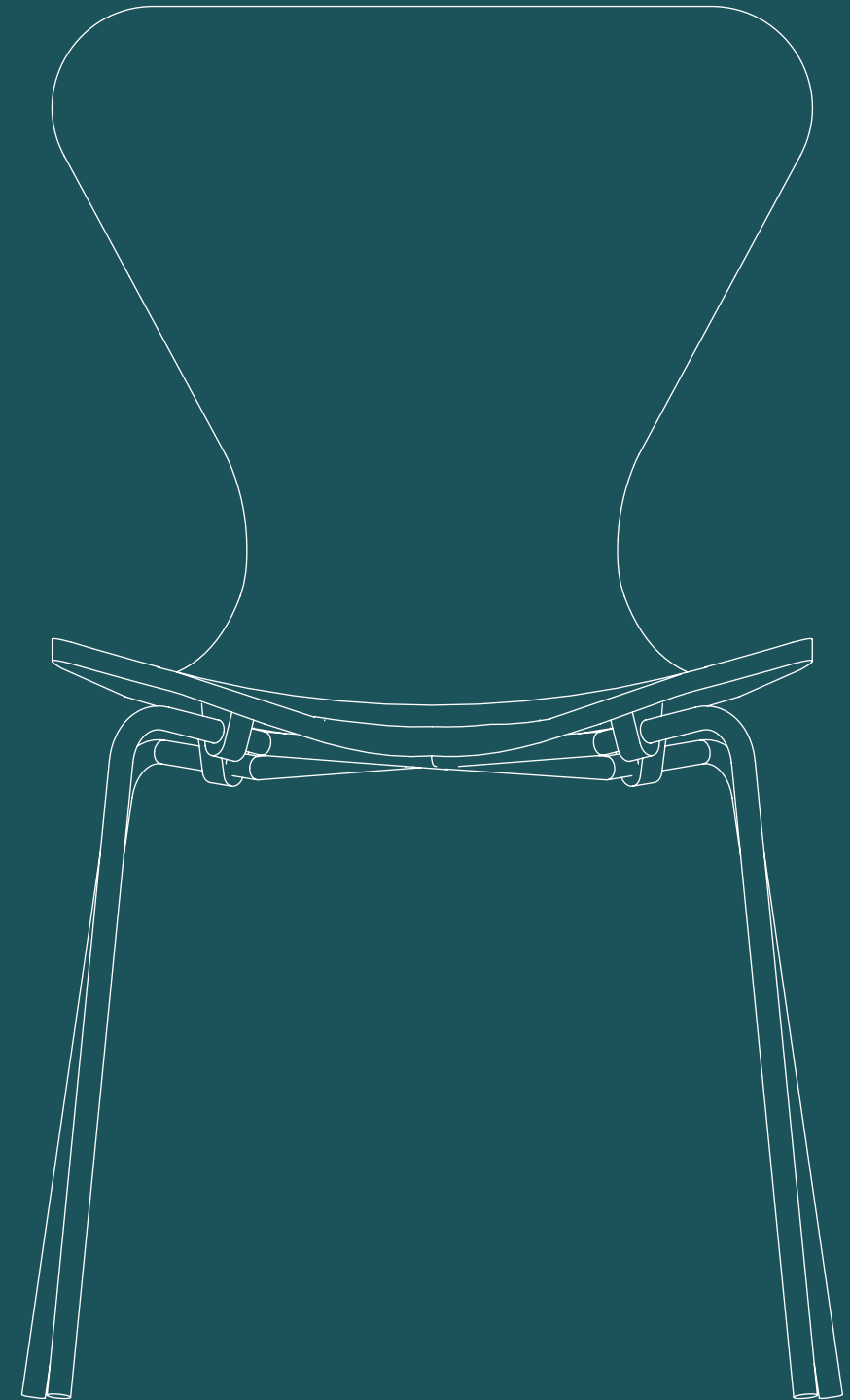

# ATLANTIC | ARCTIC

## ESCRITÓRIO OFICINA

ESTRUTURA EM TUBO DE AÇO QUADRADO OU RECTANGULAR. PÉS COM NIVELADORES. TAMPO ELEVADO EM MELAMINA OU AGLOMERADO FOLHEADO A MADEIRA. PÉ EM "U" OU EM "O".  
ESTRUCTURA EN TUBO DE ACERO CUADRADO O RECTANGULAR. PIES CON NIVELADORES. ENCIMERA ELEVADA EN MELAMINA O AGLOMERADO CHAPADO A MADEIRA. PIE EN "U" O EN "O".



DES-MONTÁVEL  
DES-MONTABLE



ATL.MR



ATL.M + ATLA + A.BR

ATL.MR  
Mesa de reuniões Atlantic  
Mesa de reuniones Atlantic

ATL.M + ATLA  
Secretária com alonga Atlantic  
Escritorio con ala Atlantic

A.BR  
Bloco rodado  
Buc con ruedas

AR.O  
Secretária com pés em "O" Arctic  
Escritorio con pies en "O" Arctic

AR.M  
Armário com portas em madeira Arctic  
Armario con puertas en madera Arctic



AR.2



AR.O



AR.M

# SERIES 7

## CADEIRAS SILLAS

CASCO EM CONTRAPLACADO DE MADEIRA, FOLHEADO A FAIA.  
CASCO EN CONTRACHAPADO DE MADEIRA, CHAPADO EN HAYA.

AJS7S  
Cadeira simples  
Silla simple

AJS7B  
Cadeira com braços  
Silla con brazos



AJS7S



AJS7B

# RETA

SIMPLICIDADE E FUNCIONALIDADE  
SIMPLICIDAD Y FUNCIONALIDAD

TAMPO DAS MESAS EM AGLOMERADO DE MADEIRA. FOLHEADO A FAIA COM ORLAS EM MADEIRA MACIÇA. ESTRUTURA EM TUBO DE AÇO INOXIDÁVEL ESCOVADO OU LACADO.  
ENCIMERA EN AGLOMERADO DE MADERA. CHAPADO EN HAYA Y CANTEADO EN MADERA MACIZA. ESTRUCTURA EN TUBO DE ACERO INOXIDABLE CEPILLADO O LACADO.

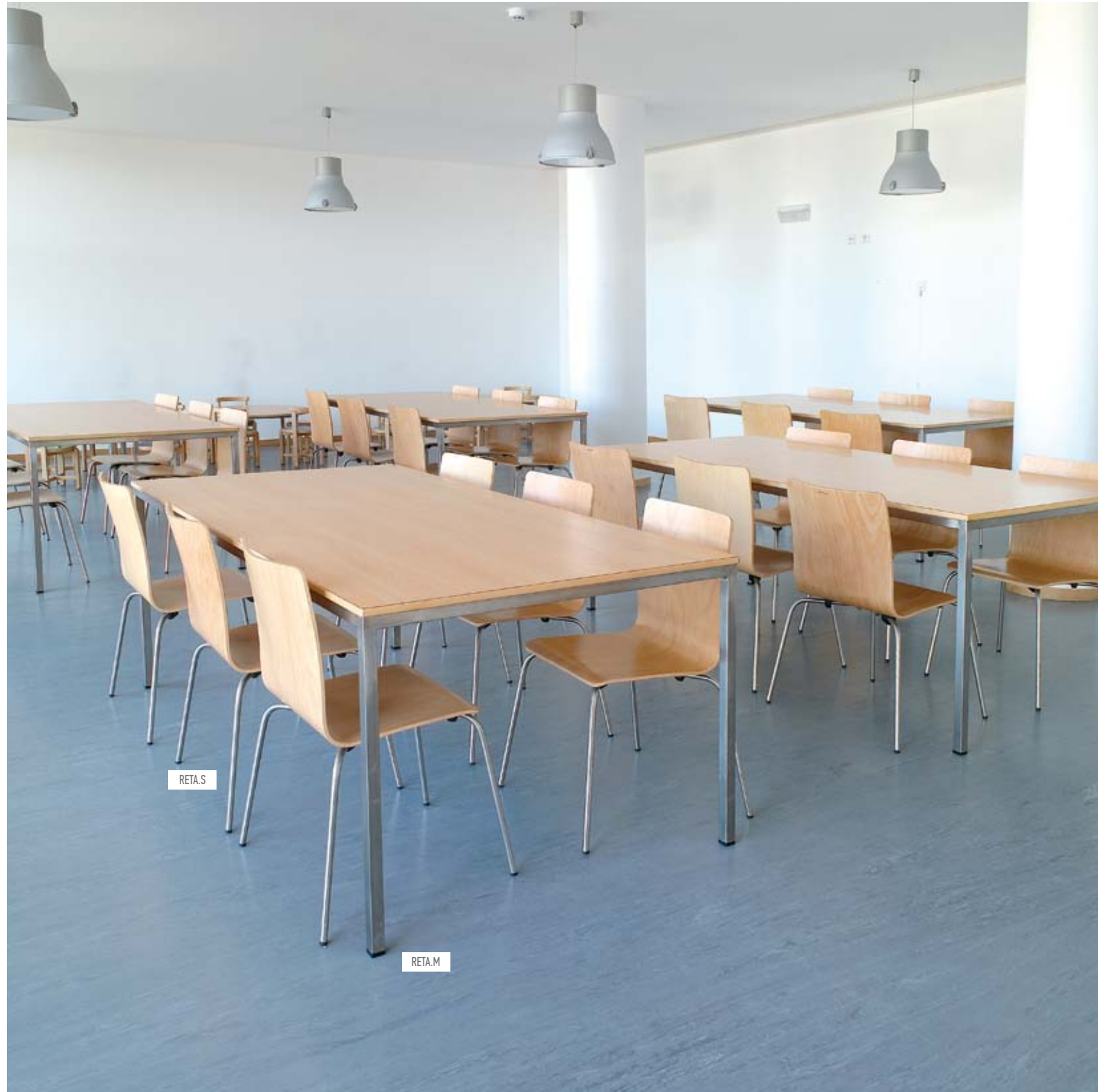

RETA.S

RETA.M



RETA.MP



RTBR



RETA.GE



RETA.B

RETA.S  
Cadeira simples  
Silla simples

RETA.M  
Mesa  
Mesa

RETA.MP  
Secretária com painel frontal  
Mesa con faldón

RTBR  
Bloco de gavetas  
Buc con ruedas

RETA.GE  
Mesa circular  
Mesa circular

RETA.B  
Cadeira com braços  
Silla con brazos



# MAIS | RETA

CONFORTO E DURABILIDADE  
COMODIDAD Y DURABILIDAD

ESTRUTURA EM AÇO. ASSENTO E ENCOSTO EM POLIPROPILENO (MAIS). CASCO EM CONTRAPLACADO LACADO (RETA).  
ESTRUCTURA EN ACERO. ASIENTO Y RESPALDO EN POLIPROPILENO (MAIS). CASCO EN CONTRACHAPADO LACADO (RETA).



MAIS VIGA.AP



RETA.AP

**MAIS VIGA.AP**  
Cadeira em viga autoportante  
Silla en viga autoportante

**RETA.AP**  
Cadeira em viga autoportante  
Silla en viga autoportante

**TSERG**  
Trolley com tabuleiros  
Trolley con bandejas

**EDERG**  
Estante com tabuleiros  
Estantería con bandejas

**T2**  
Tabuleiro em polipropileno  
Bandeja en polipropileno



TSERG



EDERG



T2

DIVERSOS  
DIVERSOS

NOVA

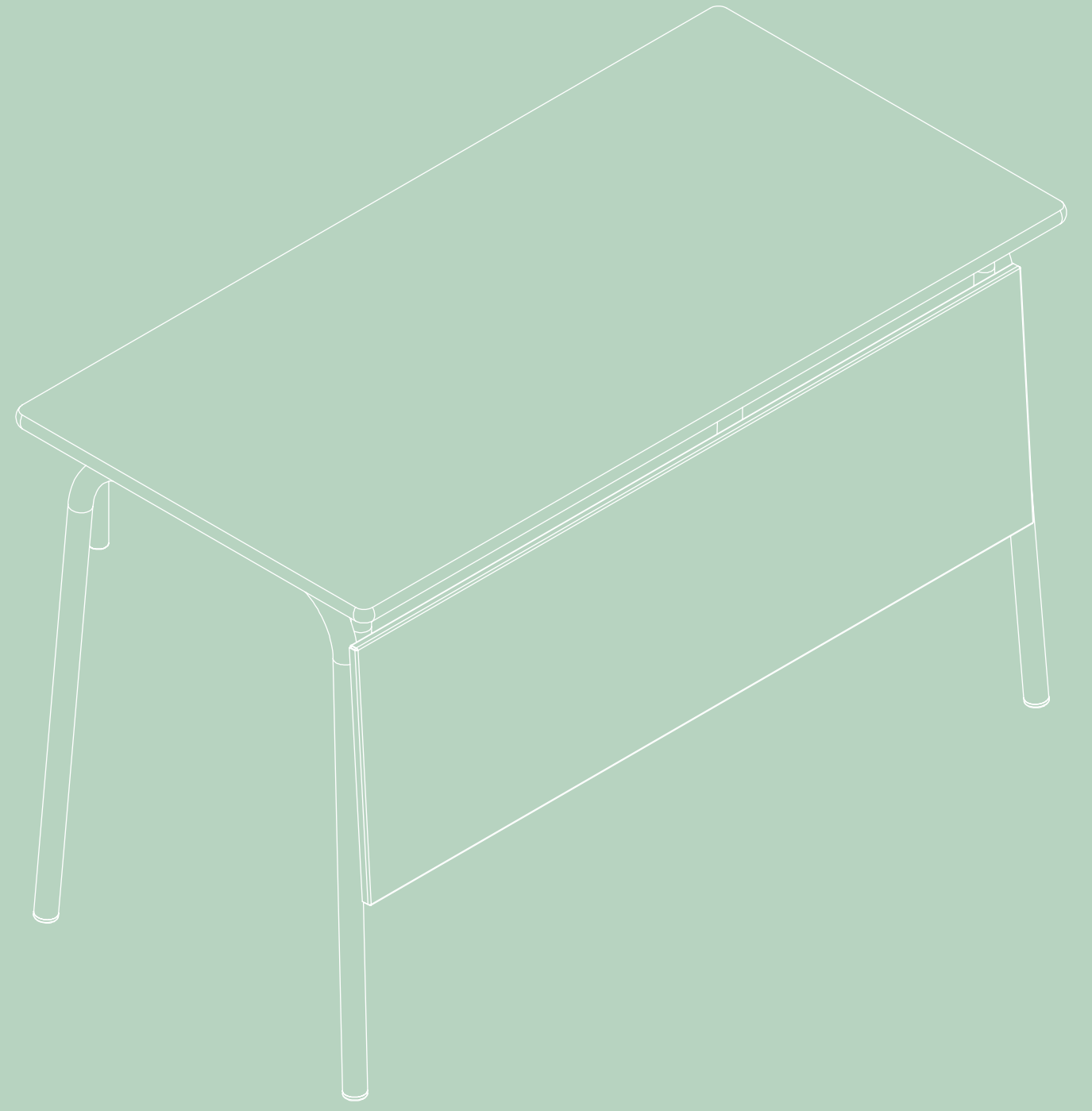

SIMPLICIDADE E FUNCIONALIDADE  
SIMPLICIDAD Y FUNCIONALIDAD

TAMPO EM AGLOMERADO DE MADEIRA. ESTRUTURA METÁLICA COM PINTURA EPOXY.  
ENCIMERA EN AGLOMERADO DE MADEIRA. ESTRUCTURA METÁLICA CON PINTURA EPOXI.

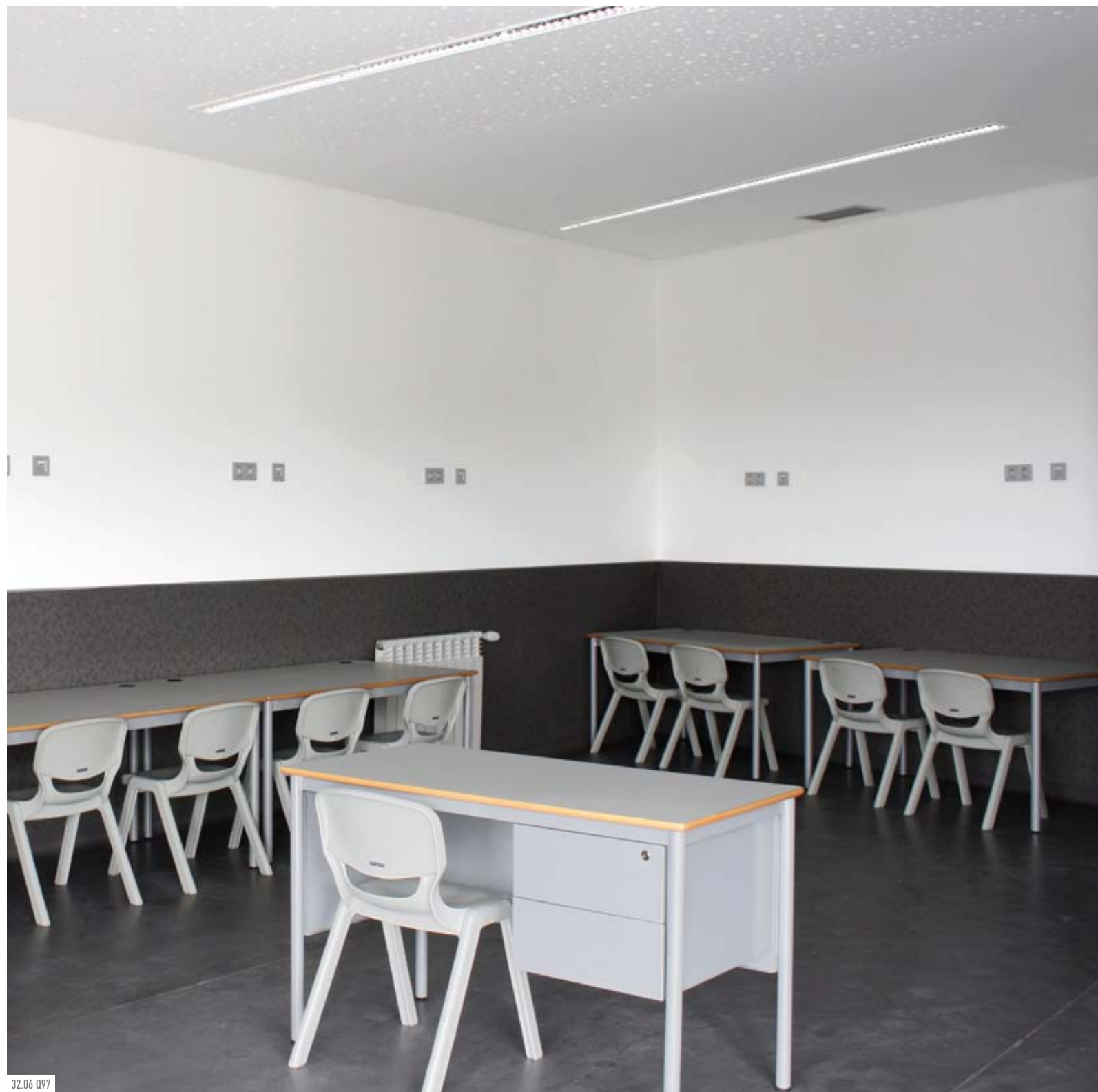

32.06 097



Fh 01



Qp

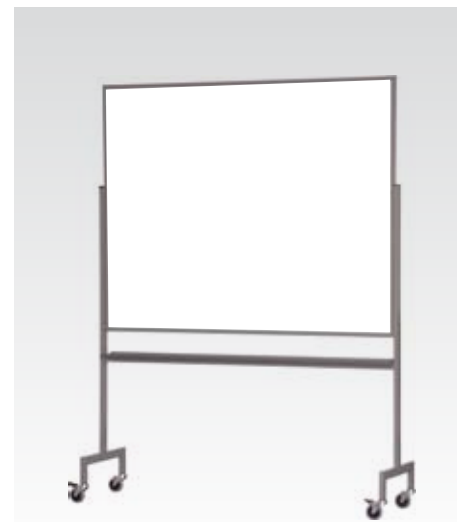

RB 42



Qc



La 06



La 04



La 05

32.06 097  
Mesa de professor  
Mesa de profesor

Fh 01  
Mesa de professor  
Mesa de profesor

Qp  
Quadro branco  
Pizarra blanca

Rb 42  
Quadro branco móvel  
Pizarra blanca móvil

Qc  
Quadro em cortice  
Tablero de corcho

La 06  
Armário portas de persiana  
Armario puertas de persiana

La 04  
Armário portas de correr  
Armario puertas correderas

La 05  
Armário arquivo  
Armario archivo

TECNOLOGIA  
TECNOLOGÍA

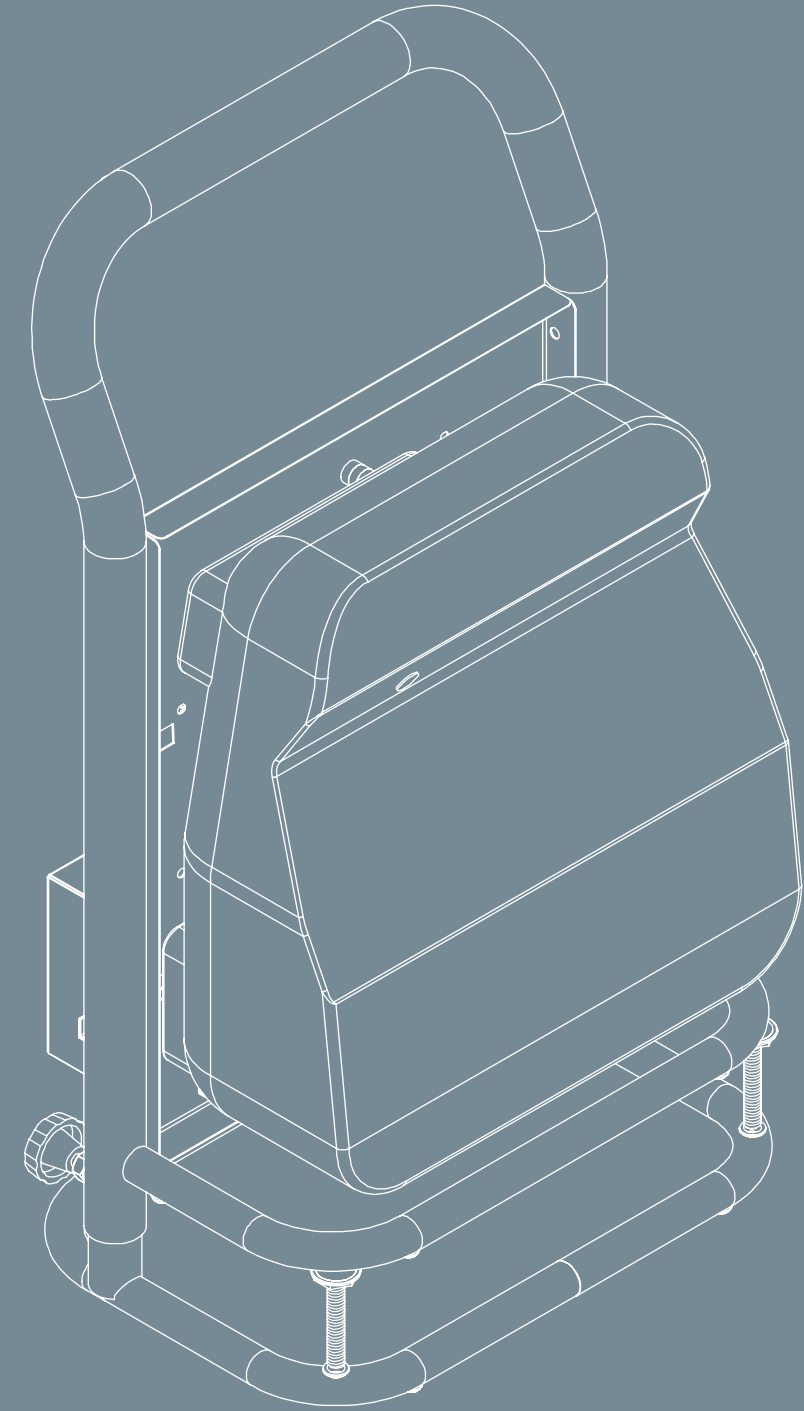
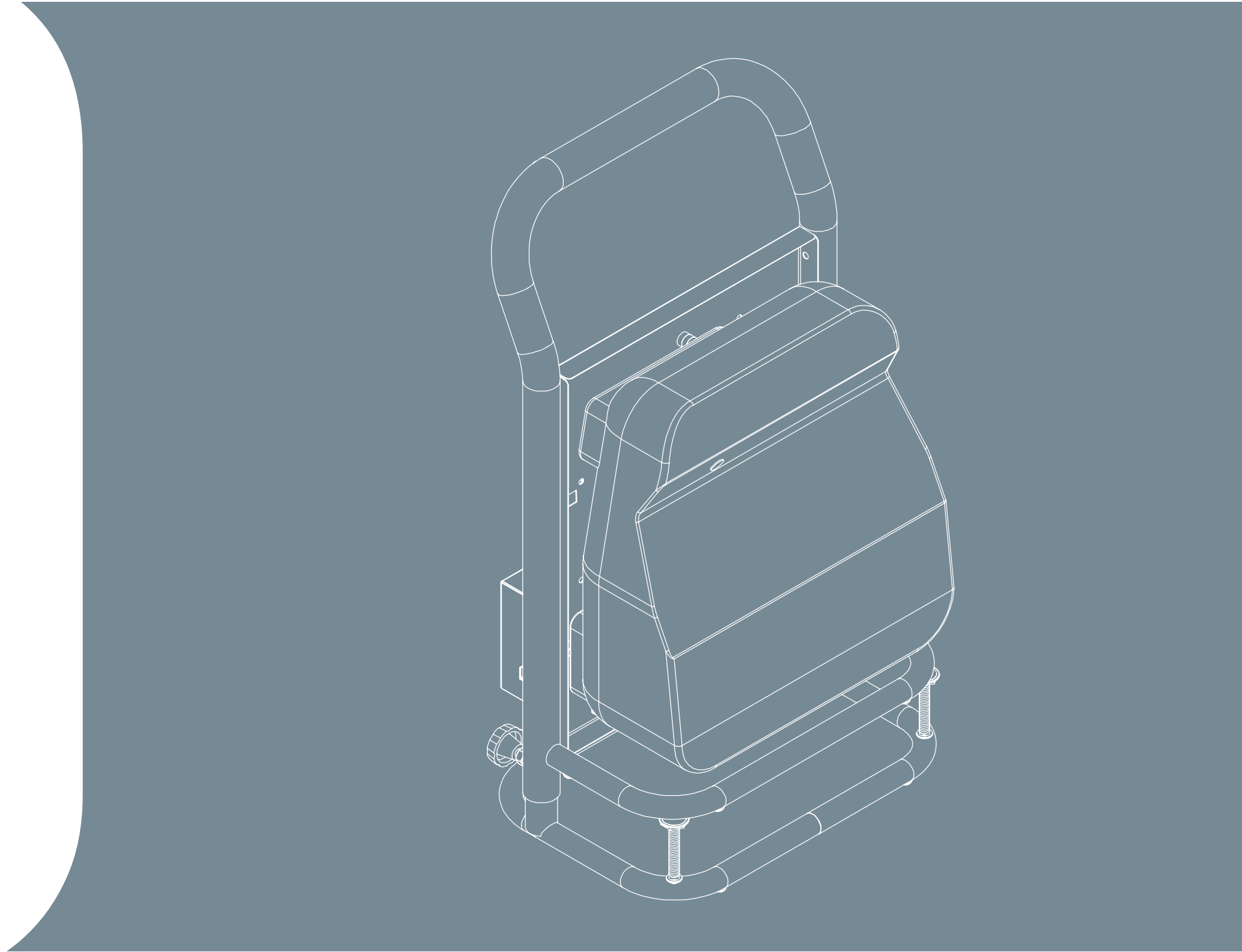
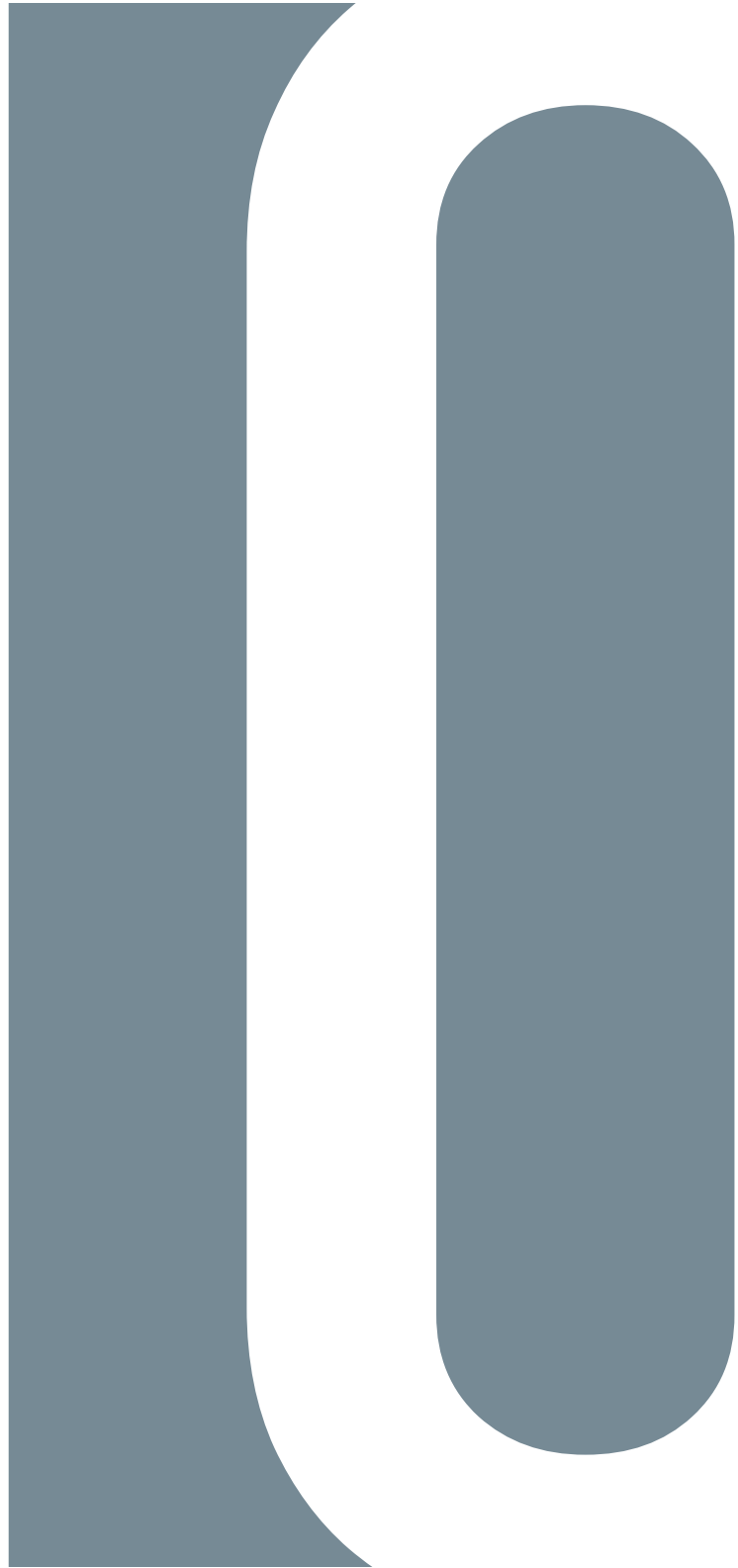

# NETBOARD EASY LED

FORMAÇÃO EM TODAS AS IDADES  
FORMACIÓN EN TODAS LAS EDADES

O NETBOARD EASY LED PERMITE A INTERAÇÃO COM UM SIMPLES TOQUE. POSSIBILITA A PARTILHA DE INFORMAÇÃO E A COLABORAÇÃO ENTRE COLEGAS.  
EL NETBOARD EASY LED PERMITE LA INTERACCIÓN CON UN SIMPLE TOQUE. HABILITA EL INTERCAMBIO DE INFORMACIÓN Y LA COLABORACIÓN ENTRE PERSONAS.



 INCLUI SOFTWARE INTERATIVO  
INCLUYE SOFTWARE INTERACTIVO



**REGULAÇÃO**  
Com altura regulável através de motor elétrico, ajusta-se à estatura dos diferentes utilizadores e à dimensão da audiência.

**REGULACIÓN**  
Con altura regulable por motor eléctrico, se ajusta a la altura de los diferentes usuarios y el tamaño de la audiencia.



**MOBILIDADE**  
Disponível em estrutura móvel, com 4 rodízios com travão ou em estrutura fixa à parede, ambas reguláveis em altura.

**MOVILIDAD**  
Disponible en estructura móvil con 4 ruedas con freno o estructura fija a la pared, ambos regulables en altura.



**INTERATIVIDADE**  
Com ecrã touch, permite tomar notas e partilhar ideias com um simples toque.

**INTERACTIVIDAD**  
Con pantalla táctil, permite tomar notas y compartir ideas con un simple toque.



**INTEGRAÇÃO**  
Pode incorporar dispositivos periféricos como um sistema de videoconferência. Caixa opcional para colocação de um computador.

**INTEGRACIÓN**  
Puede incorporar dispositivos periféricos, como un sistema de videoconferencia. Caja opcional para la colocación de un ordenador.



Ecrã táctil 55", 70" e 84"  
Pantalla táctil de 55", 70" y 84"



Sem caixa opcional  
Sin caja opcional



Opção de fixação na parede  
Opción de fijación mural



# NETBOARD FLOW

DE QUADRO A MESA  
DE PIZARRA A MESA

QUADRO INTERATIVO OU MESA INTERATIVA. BLOQUEÁVEL EM QUALQUER ÂNGULO INTERMÉDIO, A TRANSIÇÃO ENTRE QUADRO E MESA É FEITA DE FORMA SIMPLES, RÁPIDA E SEGURA.  
PIZARRA INTERACTIVA O MESA INTERACTIVA. BLOQUEABLE EN CUALQUIER ÁNGULO INTERMEDIO, LA TRANSICIÓN ENTRE PIZARRA Y MESA ES HECHA DE MANERA SIMPLE, RÁPIDA Y SEGURA.



**netboard**  
FLOW

55° - 84°

0° - 90°

↑  
↓

 INCLUI SOFTWARE INTERATIVO  
INCLUYE SOFTWARE INTERACTIVO



Interatividade e  
escrita com marcador  
Interactividad y  
escrita con bolígrafo



Versão de parede  
Versión de pared



Regulación em altura de 70 cm  
Regulación en altura de 70 cm



Facilidade de passagem nas portas  
Facilidad de desplazamiento entre espacios



**INTERATIVIDADE**  
Permite a colaboração de múltiplos utilizadores utilizando um ecrã interativo ou projetor interativo.

**INTERACTIVIDAD**  
Permite la colaboración de varios usuarios utilizando una pantalla interactiva o proyector interactivo.



**INTEGRAÇÃO E VERSATILIDADE**  
Solução 2 em 1 – Quadro interativo e mesa interativa. A transição entre quadro e mesa é feita em segundos. Versátil, permite o uso interativo ou uso como quadro tradicional.

**INTEGRACIÓN Y VERSATILIDAD**  
Solución 2 en 1 - Pizarra interactiva y mesa interactiva. La transición entre pizarra y la mesa se hace en cuestión de segundos. Versátil, permite un uso interactivo o como pizarra tradicional.



**ERGONOMIA**  
Solução ajustável em altura adequada para todos os grupos etários. Ajuste da inclinação (ângulo) entre 0° e 90° e bloqueável em qualquer posição intermédia.

**ERGONOMÍA**  
Solución regulable en altura adecuada para todos los grupos de edad. Ajuste de la inclinación (ángulo) entre 0° y 90° y bloqueable en cualquier posición intermedia.



**SEGURANÇA E ROBUSTEZ**  
As rodas com travão garantem estabilidade. Todos os componentes são bloqueáveis para prevenir potenciais roubos. Estrutura produzida em aço com pintura epoxy de alta resistência.

**SEGURIDAD Y RESISTENCIA**  
Las ruedas con freno garantizan la estabilidad. Todos los componentes se pueden cerrar para evitar posibles robos. Estructura producida en acero con pintura epoxi de alta resistencia.

# NETBOARD STANDARD

APRENDIZAGEM ESTIMULANTE  
APRENDIZAGEM DINÂMICO

INCLUI UMA CAIXA BAIXA QUE PODE SER ADAPTADA PARA O ARMAZENAMENTO E CARREGAMENTO DE TABLETS. PROJETOR DE CURTA OU ULTRA-CURTA DISTÂNCIA.  
INCLUYE UNA CAJA INFERIOR QUE PUEDE SER ADAPTADA PARA EL ALMACENAMIENTO Y CARGA DE TABLETS. PROYECTOR DE CORTA O ULTRACORTA DISTANCIA.



 INCLUI SOFTWARE INTERATIVO  
INCLUYE SOFTWARE INTERACTIVO



**MOBILIDADE**  
A estrutura garante a passagem por portas com facilidade através do braço rotativo, dos 4 rodízios com travão e da regulação da altura.

**MOVILIDAD**  
Su estructura asegura el desplazamiento con facilidad por medio del brazo giratorio, de las 4 ruedas con freno y de la regulación en altura.



**INTERATIVIDADE**  
Disponível com braço de curta ou ultra-curta distância, oferece 3 opções de Interatividade: quadro touch, projetor interativo ou sensor interativo.

**INTERACTIVIDAD**  
Disponible con brazo de corta o ultracorta distancia, ofrece tres opciones para la interactividad: pizarra táctil, proyector interactivo o sensor interactivo.



**QUADRO**  
Quadro interativo ou de porcelana, permite sempre a utilização intensa de marcadores e apagadores. Disponível em 4:3 ou 16:9, resistente a riscos ou cortes, com tratamento antirreflexo.

**PIZARRA**  
Pizarra interactiva o en cerámica, permite siempre el uso intensivo de los marcadores y borradores. Disponible en 4:3 o 16:9, resistente a los arañazos y cortes, con tratamiento antirreflejo.



**INTEGRAÇÃO E VERSATILIDADE**  
A caixa baixa pode ser adaptada para armazenar e carregar 30 tablets em simultâneo. Todas as ligações dos componentes elétricos são realizadas dentro da caixa. A ligação à eletricidade é feita através de um só cabo.

**INTEGRACIÓN Y VERSATILIDAD**  
La caja inferior puede ser adaptada para almacenar y cargar 30 tabletas al mismo tiempo. Todas las conexiones de los componentes eléctricos se realizan dentro de la caja. La conexión eléctrica se realiza a través de un solo cable.



**Facilidade de passagem nas portas**  
Facilidad de desplazamiento entre aulas



**Opção de armazenamento de tablets**  
Opción de almacenamiento de tabletas



**Opção de fixação à parede**  
Opción fijación mural

# NETBOARD EASY

PARA MELHORES RESULTADOS  
PARA MEJORES RESULTADOS

INTEGRA NUMA SÓ SOLUÇÃO: VIDEOPROJETOR, QUADRO E SUPORTE REGULÁVEL EM ALTURA POR COMANDO. O PROFESSOR PODE PARTILHAR E REUTILIZAR CONTEÚDOS DINÂMICOS.  
INTEGRA EN UNA ÚNICA SOLUCIÓN: PROYECTOR, PIZARRA Y SOPORTE REGULABLE EN ALTURA POR EL MANDO. EL PROFESOR PUEDE COMPARTIR Y REUTILIZAR CONTENIDOS DINÁMICOS.



netboard  
EASY

INCLUI SOFTWARE INTERATIVO  
INCLUYE SOFTWARE INTERACTIVO

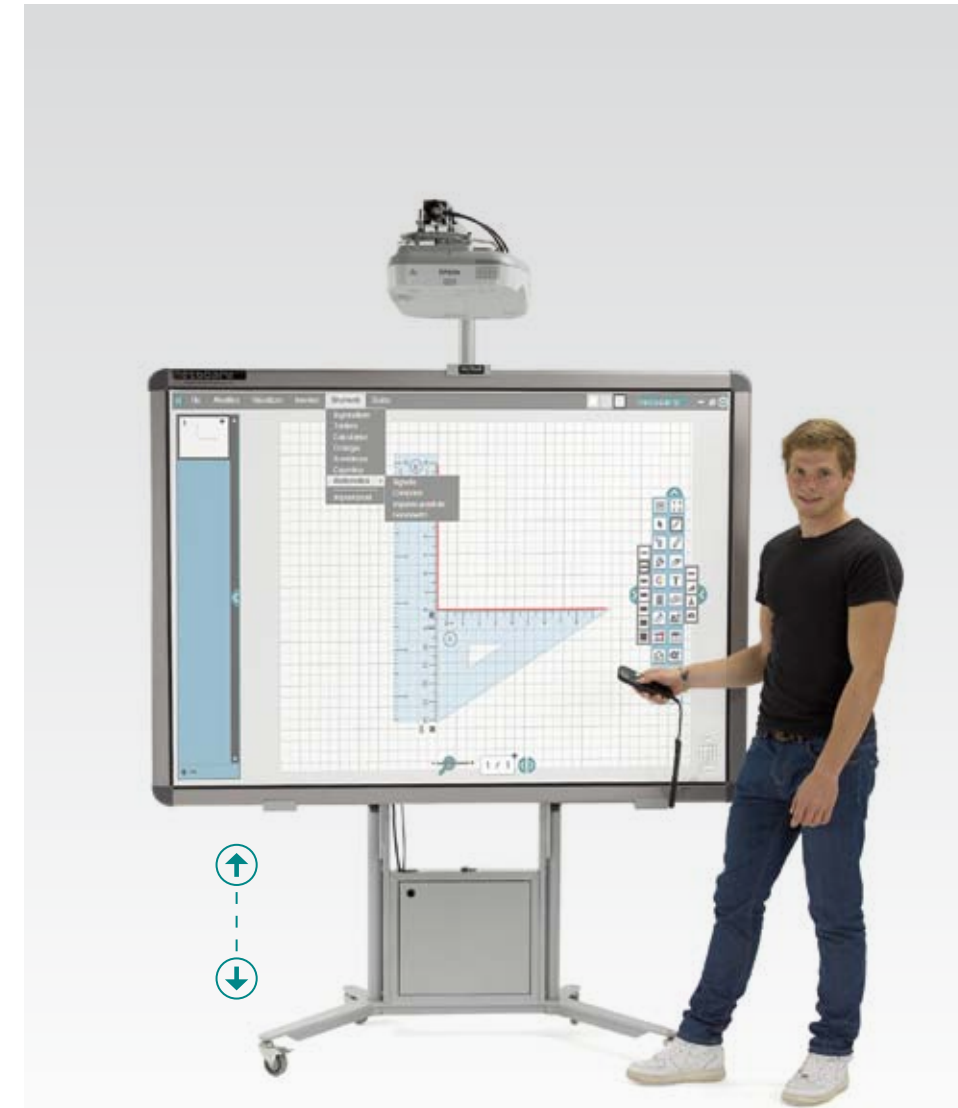

Caixa opcional  
Caja opcional



Braço rotativo  
Brazo rotatorio



Opção de fixação na parede  
Opción de fijación mural



## MOBILIDADE

A estrutura garante a passagem por portas com facilidade através do braço rotativo, dos 4 rodízios com travão e da regulação da altura.

## MOVILIDAD

Su estructura asegura el desplazamiento con facilidad por medio del brazo giratorio, de las 4 ruedas con freno y de la regulación en altura.



## INTERATIVIDADE

Disponível com braço de curta ou ultra-curta distância, oferece 3 opções de Interatividade: quadro touch, projetor interativo ou sensor interativo.

## INTERACTIVIDAD

Disponible con brazo de corta o ultracorta distancia, ofrece tres opciones para la interactividad: pizarra táctil, proyector interactivo o sensor interactivo.



## QUADRO

Quadro interativo ou de porcelana, permite sempre a utilização intensa de marcadores e apagadores. Disponível em 4:3 ou 16:9, resistente a riscos ou cortes, com tratamento antirreflexo.

## PIZARRA

Pizarra interactiva o en cerámica, permite el uso intensivo de los marcadores y borradores. Disponible en 4:3 o 16:9, resistente a los arañazos o cortes, con tratamiento antirreflejo.



## INTEGRAÇÃO E VERSATILIDADE

Disponível em estrutura móvel ou fixa à parede, ambas reguláveis em altura através de motor elétrico. Caixa opcional para colocação de um computador.

## INTEGRACIÓN Y VERSATILIDAD

Disponible en estructura móvil o fija a la pared, ambos ajustables en altura por motor eléctrico. Caja opcional para la colocación de un ordenador.







# NETBOARD PORTABLE

SOLUÇÃO 4 EM 1  
SOLUCIÓN 4 EN 1

OS ALUNOS PODEM INTERAGIR INTUITIVAMENTE COM CONTEÚDOS EDUCATIVOS EM VÁRIAS SUPERFÍCIES, DESENVOLVENDO AS SUAS CAPACIDADES MOTORAS, COGNITIVAS E SOCIAIS.  
LOS ALUMNOS PUEDEN INTERACTUAR INTUITIVAMENTE CON CONTENIDOS EDUCATIVOS EN DIVERSAS SUPERFICIES, FAVORECIENDO EL DESARROLLO DE SUS HABILIDADES MOTORAS, COGNITIVAS Y SOCIALES.













Mesa  
Mesa





Fixação na parede  
Fijación en la pared



Parede  
Pared









**MOBILIDADE**  
Permite alterar a disposição em sala de aula sem esforço e sem necessidade de recalibração. Tem como acessório um trolley para deslocação entre salas.

**MOVILIDAD**  
Permite cambiar la disposición del aula sin esfuerzo y sin necesidad de recalibración. Tiene como accesorio un trolley para desplazarse entre las aulas y espacios.



**INTEGRAÇÃO**  
Pode incorporar uma bandeja para colocação de um portátil ou integrar um micro-pc, garantindo a ligação à corrente através de um único cabo de alimentação.

**INTEGRACIÓN**  
Puede incorporar una bandeja para colocación de un ordenador portátil o la integración de un microordenador, asegurando la toma de corriente a través de un cable de alimentación.



**INTERACTIVIDADE**  
Toma qualquer superfície plana numa tela interativa. Para uma projeção mais clara tem como acessório um tapete. Inclui calibração automática e duas canetas interativas, possibilitando a colaboração de vários utilizadores.

**INTERACTIVIDAD**  
Convierte cualquier superficie plana en una pantalla interactiva. Para una proyección más clara tiene como accesorio una pantalla. Incluye calibración automática y dos bolígrafos interactivos, lo que permite la colaboración de varios usuarios.



**SEGURANÇA E ROBUSTEZ**  
A sua estrutura robusta e sem arestas garante estabilidade para evitar a queda. O sistema de fixação à mesa, ajustável manualmente, ajusta-se a tempos de mesa com diferentes espessuras.

**SEGURIDAD Y RESISTENCIA**  
Su estructura robusta y sin bordes asegura la estabilidad para no caer. El sistema de fijación a la mesa, manualmente ajustable, se adapta a tapas de mesa de diferentes espesores.

# UNI\_NET

DESIGN FUNCIONAL  
DISEÑO FUNCIONAL

ALÉM DO SEU PROPÓSITO COMO MESA DE ALUNO, INCORPORA AINDA UM COMPUTADOR. A MESA LIGA-SE AO QUADRO INTERATIVO E AO COMPUTADOR DO PROFESSOR.  
ADEMÁS DE SU PROPÓSITO COMO UNA MESA DE ALUMNO, TAMBIÉN INCORPORA UN ORDENADOR. LA MESA SE CONECTA A LA PIZARRA INTERACTIVA Y AL ORDENADOR DEL PROFESOR.



 INCLUI SOFTWARE INTERATIVO  
INCLUYE SOFTWARE INTERACTIVO



**INTEGRAÇÃO E VERSATILIDADE**  
Mesa 2 em 1 – Mesa de escrita e mesa de computador. O monitor, teclado e rato são facilmente ocultados.

**INTEGRACIÓN Y VERSATILIDAD**  
Mesa 2 en 1 – Mesa de alumno y mesa de ordenador. El monitor, teclado y ratón se ocultan fácilmente.



**SEGURANÇA**  
Para uma melhor organização da sala de aula, todos os componentes eletrónicos estão protegidos (não existem cabos soltos).

**SEGURIDAD**  
Para una mejor organización de la clase, todos los componentes electrónicos están protegidos (no hay cables sueltos).



**ERGONOMIA**  
Com um design simples e funcional, permite rentabilizar o espaço, duplicando o uso de cada sala TIC.

**ERGONOMÍA**  
Con un diseño sencillo y funcional, permite maximizar el uso del espacio, duplicando el uso de cada sala TIC.



Mesa de professor  
Mesa del profesor



Mesa dupla com 1 PC  
Mesa doble con 1 ordenador



Mesa dupla com 2 PCs  
Mesa doble con 2 ordenadores



# NETPOWER

## SALA DE AULA DIGITAL AULA DIGITAL

AJUSTÁVEL EM ALTURA, A NETPOWER É UMA SOLUÇÃO INTERATIVA, COM UM COMPUTADOR AIO COM ECRÃ TÁCTIL MULTI-TOUCH QUE PODE SER UTILIZADO COMO MESA DE ALUNO OU PÚLPITO.  
REGULABLE EN ALTURA, LA NETPOWER ES UNA SOLUCIÓN INTERACTIVA, CON UN ORDENADOR AIO CON PANTALLA TÁCTIL MULTITÁCTIL QUE PUEDE SER UTILIZADO COMO MESA DE ALUMNO O PÚLPITO.



 INCLUI SOFTWARE INTERATIVO  
INCLUYE SOFTWARE INTERACTIVO



Ajustável em altura  
Regulable en altura



Fixa em altura  
Altura fija



Púlpito com ecrã táctil  
Púlpito con pantalla táctil



**INTERATIVIDADE**  
Pode ser ligada em rede para trabalho colaborativo. O ecrã tátil permite trabalhar intuitivamente e é uma mais-valia para a educação especial.

**INTERACTIVIDAD**  
Se puede conectar en red para el trabajo colaborativo. La pantalla táctil le permite trabajar de forma intuitiva y es un activo para la educación especial.



**INTEGRAÇÃO**  
A NETPOWER incorpora um computador AIO com um monitor tátil capacitivo de 21,5". A NETPOWER CANVAS tem um monitor tátil capacitivo de 27" para adicionar interatividade a qualquer sistema de projeção.

**INTEGRACIÓN**  
La NETPOWER incorpora un ordenador AIO con una pantalla táctil capacitiva de 21.5". La NETPOWER CANVAS tiene una pantalla táctil capacitiva de 27" para añadir interactividad a cualquier sistema de proyección.



**MOBILIDADE**  
A estrutura leve com rodas integradas permite alterar facilmente o layout da sala de aula. O ecrã é rebatível para arrumação e transporte.

**MOVILIDAD**  
La estructura ligera con ruedas integradas hace que sea fácil de cambiar la disposición del aula. La pantalla es plegable para el almacenamiento y el transporte.



**VERSATILIDADE**  
Com ligação ao sistema de projeção, o professor, aluno ou qualquer outro orador passa a estar de frente para a turma ou audiência.

**VERSATILIDAD**  
Conectado con el sistema de proyección, el profesor, estudiante o cualquier otro orador puede estar de frente a la clase o audiencia.

# NETPOWER

## SALA DE AULA DIGITAL AULA DIGITAL

INTEGRA UMA SUPERFÍCIE DE ESCRITA COM SUPORTE PARA TABLET PARA A UTILIZAÇÃO FÁCIL DE DISPOSITIVOS ELETRÔNICOS NA SALA DE AULA. INCLUI UMA BATERIA PARA CARREGAMENTO DE QUALQUER DISPOSITIVO ELETRÔNICO. INCLUYE UNA SUPERFÍCIE DE ESCRITURA CON SOPORTE PARA TABLETAS PARA FACILITAR EL USO DE DISPOSITIVOS ELECTRÓNICOS EN EL AULA. INCLUYE UNA BATERÍA PARA CARGAR CUALQUIER DISPOSITIVO ELECTRÓNICO.

netpower  
MOBILE



Palmatória rotativa  
Pala de escritura rotativa



Carrega qualquer dispositivo eletrônico  
Carga cualquier dispositivo electrónico



Rodas para mobilidade  
Ruedas para movilidad



### VERSATILIDADE

O suporte para tablet foi desenhado para permitir a colocação do tablet na horizontal ou na vertical. A cadeira rodada permite alterar a configuração da sala de aula em segundos, dependendo do tipo de ensino e estilo de aprendizagem pretendido, e potencializam uma interação ativa e socializante dos alunos, melhorando os resultados da aula.

### VERSATILIDAD

El soporte para tableta fue diseñado para colocar la tableta horizontal o verticalmente. La silla con ruedas permite cambiar la configuración del aula en cuestión de segundos, dependiendo del tipo de enseñanza y estilo de aprendizaje deseado, y permite una interacción activa y social entre los alumnos, lo que mejora los resultados de la clase.



### INTERATIVIDADE E INTEGRAÇÃO

A bateria integrada permite carregar dispositivos móveis, garantindo o seu funcionamento durante todo o dia. O braço rotativo da superfície para escrita permite o seu afastamento para uma saída sem dificuldades. Com o suporte para tablet os alunos facilmente combinam materiais de estudo físicos e digitais.

### INTERATIVIDAD E INTEGRACIÓN

La batería integrada permite cargar dispositivos móviles, lo que garantiza su funcionamiento durante todo el día. El brazo giratorio de la pala de escritura permite su retirada para salir con facilidad. Con el soporte para tabletas los alumnos combinan con facilidad materiales de estudio físicos y digitales.

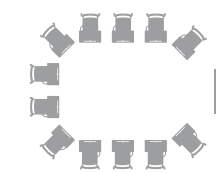
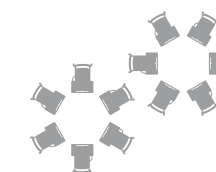

# ONE POWERSTATION

ENSINO DIGITAL  
ENSEÑANZA DIGITAL

É A SOLUÇÃO PARA AS ESCOLAS DE HOJE QUE ESTÃO A ADOTAR OS TABLETS NA SALA DE AULA. COM A ONE POWERSTATION NÃO EXISTEM FALHAS DE BATERIA.  
ES LA SOLUCIÓN PARA LAS ESCUELAS DE HOY EN DÍA QUE HAN INCORPORADO LAS TABLETAS EN EL AULA. CON LA ONE POWERSTATION NO HAY CORTES DE BATERIA.

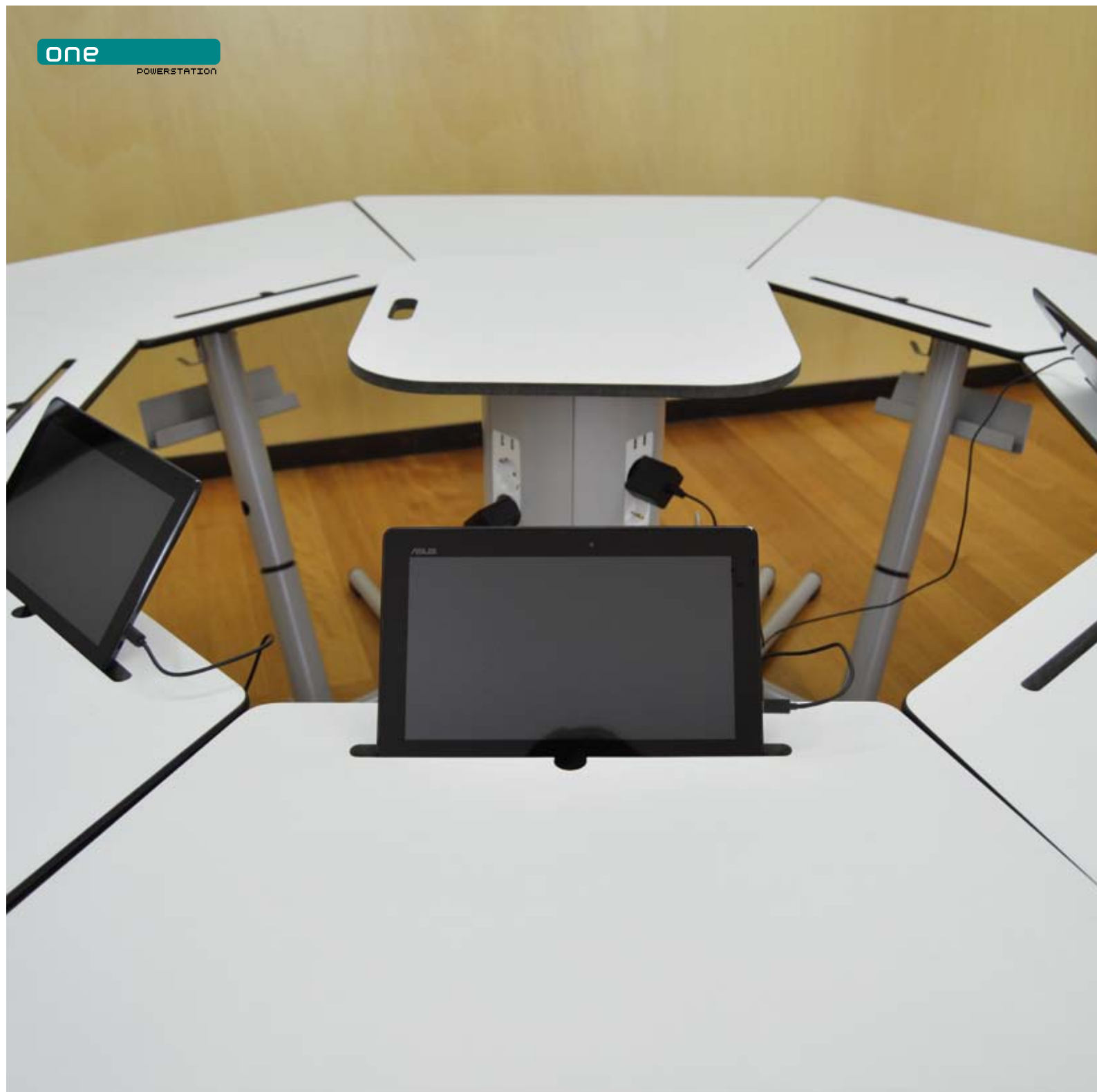

Carrega até 12 dispositivos em simultâneo  
Cargas de hasta 12 dispositivos en simultáneo



Rodas para mobilidade  
Ruedas para movilidad



Carregamento por USB ou tomada  
Carga por USB o enchufe



**VERSATILIDADE**  
Ligação à energia por tomadas (carrega 12 dispositivos em simultâneo) ou por portas USB (carrega 8 dispositivos em simultâneo) com um circuito especial integrado para maior velocidade.

**VERSATILIDAD**  
Conexión de energía por enchufes (carga 12 dispositivos simultáneamente) o por USB (carga 8 dispositivos simultáneamente) con un circuito integrado especial para una mayor velocidad.



**MOBILIDADE**  
Com rodas integradas, a estrutura de peso leve tem um gancho para prender o cabo de alimentação, permitindo alterar o layout da sala de aula de forma rápida e segura.

**MOVILIDAD**  
Con ruedas integradas, la estructura de peso ligero tiene un gancho para sujetar el cable de alimentación, lo que le permite cambiar la disposición de la clase de manera rápida y segura.



# NETBOOK BUS

ARMAZENAR E CARREGAR  
ALMACENAMIENTO Y CARGA

SOLUÇÕES PARA ARMAZENAR E CARREGAR EM SEGURANÇA OS DISPOSITIVOS ELETRÔNICOS DA SALA DE AULA  
SOLUCIONES PARA ALMACENAR Y CARGAR CON SEGURIDAD LOS DISPOSITIVOS ELECTRÓNICOS DEL AULA.

netbook  
BUS



30 tablets  
30 tabletas



40 tablets ou 30 laptops  
40 tabletas o 30 portátiles



15 tablets  
15 tabletas



Espuma protetora de alta densidade  
Espuma de protección de alta densidad



Diferencial e disjuntores de proteção  
Diferencial e interruptores magnetotérmicos



Armazenamento de transformadores  
Almacenamiento adaptadores AC



## INTEGRAÇÃO

Suporta todas as marcas de tablets e portáteis. Várias configurações disponíveis para armazenar desde 15 tablets a 30 portáteis.

## INTEGRACIÓN

Compatible con todas las marcas de tabletas y ordenadores portátiles. Varias configuraciones disponibles para almacenar desde 15 tabletas hasta 30 ordenadores portátiles.



## MOBILIDADE

Os 4 rodízios de borracha permitem reorganizar a sala de aula, libertando espaço e facilitando a recolha e distribuição dos dispositivos pela sala.

## MOVILIDAD

4 ruedas de goma permiten reorganizar el aula, liberando espacio y facilitan la recogida y distribución de dispositivos en el aula.



## PROTEÇÃO

Espuma de alta densidade para proteção. Orifícios de ventilação em todas as paredes, com arrefecimento interno através de ventilação forçada. Proteção contra picos de corrente. Disjuntores, plugs individuais e um único cabo de alimentação.

## PROTECCIÓN

Espuma de alta densidad para proteger las tabletas. Agujeros de ventilación en todas las paredes, con refrigeración interna por ventilación forzada. Protección contra subidas de tensión. Interruptores magnetotérmicos, plugs individuales y un único cable de alimentación.



## SEGURANÇA

Portas ou compartimentos individuais com fechadura. Os rodízios bloqueáveis garantem estabilidade. A gestão de cabos previne que os cabos se enrolem e se danifiquem.

## SEGURIDAD

Puertas o compartimentos individuales con cerradura. Las ruedas con freno aseguran la estabilidad. La gestión de cables evita cables enrollados y dañados.

# REFERÊNCIAS

# REFERENCIAS



## 01 pré-escolar preescolar

Kit cozinha  
Kit cocina



REF. \*DIM.  
CB.KC ---

Kit biblioteca  
Kit biblioteca



REF. \*DIM.  
CB.KB ---

Kit quarto  
Kit habitación



REF. \*DIM.  
CB.KQ ---

Catre empilhável e base  
Catre apilable y base

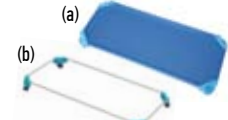

REF. \*DIM.  
(a) SP 02 130 x 55 x 11  
(b) SP 01 130 x 55 x 16

Berço  
Berço



REF. \*DIM.  
BE 01 123 x 67 x 96

Mesa em madeira  
Mesa en madera



REF. \*DIM.  
EPSAM 02 Ø90 x 47  
EPSAM 03 Ø90 x 54

Cadeira em madeira  
Silla en madera



REF. \*DIM.  
EPSAC 02 Ø32 x 27  
EPSAC 03 Ø32 x 32

Banco em madeira  
Banco en madera



REF. \*DIM.  
EPSAB 02 Ø32 x 27  
EPSAB 03 Ø32 x 32

Cadeira em polipropileno  
Silla en polipropileno



REF. \*DIM.  
ERGOS 01 30 x 32 x 27  
ERGOS 02 30 x 36 x 31

Mesa em polipropileno  
Mesa en polipropileno



REF. \*DIM.  
ERGMI 01 75 x 60 x 47  
ERGMI 02 75 x 60 x 54

Puff pera  
Puff pera



REF. \*DIM.  
PF 03 Ø 50 x 80

Puff quadrado  
Puff cuadrado



REF. \*DIM.  
PF 04 45 x 45 x 25

Banca de muda  
Armario cambiador



REF. \*DIM.  
BM01 120 x 60 x 90

Puff redondo  
Puff redondo



REF. \*DIM.  
PF01 Ø 40 x 25

Tapete  
Tapis



REF. \*DIM.  
TA 15 150 x 150 x 3  
TA 20 200 x 200 x 3

Armário com tabuleiros  
Armario con bandejas



REF. \*DIM.  
LN 12 107 x 44 x 85

Banco com tabuleiros  
Banco con bandejas



REF. \*DIM.  
BERG 04 142 x 41 x 51  
BERG 02 71 x 41 x 51

Tabuleiros  
Bandejas



REF. \*DIM.  
T1 31 x 37,5 x 7,5 (5,5 L)  
T2 31 x 37,5 x 15,5 (12 L)

## 02 cadeiras sillas

Armário com gavetas  
Armario con cajones



REF. \*DIM.  
AGJIS 100 x 40 x 100

Armário fechado  
Armario cerrado



REF. \*DIM.  
AFGIS 100 x 40 x 100

Armário com tabuleiros  
Armario con bandejas



REF. \*DIM.  
NM11 105 x 45 x 85

Armário aberto  
Armario abierto



REF. \*DIM.  
AAJIS 100 x 40 x 100

Mesa dupla  
Mesa doble



REF. \*DIM.  
FB 01 120 x 60 x 46  
FB 02 120 x 60 x 53

Cadeira em polipropileno  
Silla en polipropileno



REF. \*DIM.  
ERGOS 03 46 x 49 x 35  
ERGOS 04 46 x 49 x 39  
ERGOS 05 50 x 50 x 43  
ERGOS 06 50 x 50 x 46  
ERGOS 07 50 x 50 x 51

Cadeira  
Silla



REF. \*DIM.  
MAIS AA 04 47 x 50 x 38  
MAIS AA 05 47 x 50 x 43  
MAIS AA 06 47 x 50 x 46

Cadeira alta  
Silla alta



REF. \*DIM.  
MAIS Ah 21 47 x 50 x 65

Cadeira giratória  
Silla giratoria



REF. \*DIM.  
MAIS Ah 23 40 x 42 x 55-65

Cadeira cantilever invertido  
Silla cantilever inversa



REF. \*DIM.  
MAIS UNI AA04 48 x 51 x 38  
MAIS UNI AA05 48 x 51 x 43  
MAIS UNI AA06 48 x 51 x 46

Mesa trapezoidal  
Mesa trapezoidal



REF. \*DIM.  
FD 01 60/120 x 60 x 46  
FD 02 60/120 x 60 x 53

Mesa circular  
Mesa circular



REF. \*DIM.  
FE 01 Ø120 x 46  
FE 02 Ø120 x 53

Mesa semi-circular  
Mesa semicircular



REF. \*DIM.  
FF 01 Ø120 x 46  
FF 02 Ø120 x 53

Cadeira em laminado  
Silla en laminado



REF. \*DIM.  
AA 11 32 x 33 x 26  
AA 12 36 x 37 x 31

Cadeira folheada a haya  
Silla chapada a haya



REF. \*DIM.  
AA 01 32 x 33 x 26  
AA 02 36 x 37 x 31

Cadeira com palmatória  
Silla con pala



REF. \*DIM.  
MAIS AC 06 51 x 51 x 46

Cadeira Dual Step  
Silla Dual Step



REF. \*DIM.  
DS0204 40 x 37 x 31-38  
DS0406 44 x 40 x 39-46

Cadeira giratória  
Silla giratoria



REF. \*DIM.  
Ah 21 38 x 44 x 45-55

Cadeira giratória  
Silla giratoria



REF. \*DIM.  
Ah 23 38 x 44 x 55-65

Banco ajustável em altura  
Banco regulable en altura



REF. \*DIM.  
Ah 01 Ø 36 x 54-66



## 02 cadeiras sillas



Banco ajustável em altura  
Banco regulable en altura



REF. \*DIM.  
Ah 02 Ø 36 x 54-66

Cadeira em madeira  
Silla em madeira



REF. \*DIM.  
Aa 03 43 x 41 x 35  
Aa 04 44 x 46 x 38  
Aa 05 49 x 52 x 43  
Aa 06 49 x 57 x 46

Cadeira em laminado  
Silla en laminado



REF. \*DIM.  
Aa 13 43 x 41 x 35  
Aa 14 44 x 46 x 38  
Aa 15 49 x 52 x 43  
Aa 16 49 x 57 x 46

Cadeira com estrutura de aço  
Silla con estructura en acero



REF. \*DIM.  
Ma.C04 37 x 48 x 37  
Ma.C05 37 x 49 x 40  
Ma.C06 41 x 55 x 46

Cadeira cantilever invertido  
Silla cantilever inversa



REF. \*DIM.  
UNI AA 03 30 x 32 x 32  
UNI AA 04 34 x 36 x 36  
UNI AA 05 38 x 40 x 41  
UNI AA 06 38 x 40 x 45

Subtampo em rede metálica  
Bandeja en rejilla metálica



REF. \*DIM.  
DESK21 STR 73 x 32 x 7

Subtampo em chapa perfurada metálica  
Bandeja en chapa perforada metálica



REF. \*DIM.  
DESK21 STC 73 x 32 x 7

Mesa dupla com subtampo  
Mesa doble con bandeja



REF. \*DIM.  
FB 04IM 120x60x64  
FB 05IM 120x60x71  
FB 06IM 120x60x76

Mesa individual  
Mesa individual



REF. \*DIM.  
FA 03 75 x 60 x 59  
FA 04 75 x 60 x 64  
FA 05 75 x 60 x 71  
FA 06 75 x 60 x 76

Mesa individual com subtampo  
Mesa individual con bandeja



REF. \*DIM.  
FA 03i 75 x 60 x 59  
FA 04i 75 x 60 x 64  
FA 05i 75 x 60 x 71  
FA 06i 75 x 60 x 76

Cadeira regulável em altura  
Silla regulable en altura



REF. \*DIM.  
URE AA 48 x 44 x 36-45

Mesa dupla  
Mesa doble



REF. \*DIM.  
FB03 120 x 60 x 59  
FB04 120 x 60 x 64  
FB05 120 x 60 x 71  
FB06 120 x 60 x 76

Mesa dupla com subtampo  
Mesa doble con bandeja



REF. \*DIM.  
FB03i 120 x 60 x 59  
FB04i 120 x 60 x 64  
FB05i 120 x 60 x 71  
FB06i 120 x 60 x 76

Mesa de desenho  
Mesa de dibujo



REF. \*DIM.  
Ha 01 80 x 70 x 74  
Hb 01\* 90 x 70 x 85 - 100  
  
\*Regulável | Ajustable

Mesa semi-circular  
Mesa semicircular



REF. \*DIM.  
FF 03 Ø 120 x 59  
FF 04 Ø 120 x 64  
FF 05 Ø 120 x 71  
FF 06 Ø 120 x 76

Mesa circular  
Mesa circular



REF. \*DIM.  
FE 03 Ø 120 x 59  
FE 04 Ø 120 x 61  
FE 05 Ø 120 x 68  
FE 06 Ø 120 x 74  
FE 13 Ø 90 x 59  
FE 14 Ø 90 x 61  
FE 15 Ø 90 x 68  
FE 16 Ø 90 x 74

## 03 mesas mesas

Mesa individual  
Mesa individual



REF. \*DIM.  
MAIS FA 04 75 x 60 x 59  
MAIS FA 04 75 x 60 x 64  
MAIS FA 05 75 x 60 x 71  
MAIS FA 06 75 x 60 x 76

Mesa individual cantilever  
Mesa individual cantilever



REF. \*DIM.  
MAIS UNI FA 03 75 x 60 x 59  
MAIS UNI FA 04 75 x 60 x 64  
MAIS UNI FA05 75 x 60 x 71  
MAIS UNI FA 06 75 x 60 x 76

Mesa individual desmontável  
Mesa individual desmontable



REF. \*DIM.  
MAIS FAD 03 75 x 60 x 59  
MAIS FAD 04 75 x 60 x 64  
MAIS FAD 05 75 x 60 x 71  
MAIS FAD 06 75 x 60 x 76  
MAIS FA PF (painel frontal / faldón)  
MAIS FA ST (subtampo / bandeja)

Mesa regulável em altura  
Mesa regulable en altura



REF. \*DIM.  
ONE RT1 87 x 50 x 62-76  
ONE RT2 87 x 50 x 76-90

Mesa fixa em altura  
Mesa fija en altura



REF. \*DIM.  
ONE FT1 87 x 50 x 76  
ONE FT2 87 x 50 x 90

Mesa múltipla  
Mesa múltiple



REF. \*DIM.  
FC 03 120 x 80 x 59  
FC 04 120 x 80 x 64  
FC 05 120 x 80 x 71  
FC 06 120 x 80 x 76

Mesa dupla sem subtampo  
Mesa doble sin bandeja



REF. \*DIM.  
MA.FB 04 120 x 60 x 64  
MA.FB 05 120 x 60 x 71  
MA.FB 06 120 x 60 x 74

Mesa dupla com tampo inclinável  
Mesa doble con encimera inclinable



REF. \*DIM.  
MA.MAT.04 120 x 60 x 61  
MA.MAT.05 120 x 60 x 68  
MA.MAT.06 120 x 60 x 74

Mesa individual com tampo inclinável  
Mesa individual con encimera inclinable



REF. \*DIM.  
MA.MAT.1.04 75 x 60 x 61  
MA.MAT.1.05 75 x 60 x 68  
MA.MAT.1.06 75 x 60 x 74

Mesa regulável  
Mesa ajustable



REF. \*DIM.  
URE FA 75 x 60 x 61-74  
URE FB 120 x 60 x 61-74  
URE FA 678 75 x 60 x 74-87

Mesa ambidextra fixa  
Mesa ambidiestra fija



REF. \*DIM.  
DESK21 02 70 x 70 x 52  
DESK21 03 70 x 70 x 58  
DESK21 04 70 x 70 x 64  
DESK21 05 70 x 70 x 70  
DESK21 06 70 x 70 x 76  
DESK21 07 70 x 70 x 82

Mesa ambidextra alta fixa  
Mesa ambidiestra alta fija



REF. \*DIM.  
DESK21A04 70 x 70 x 89  
DESK21A05 70 x 70 x 98  
DESK21A06 70 x 70 x 107

Mesa ambidextra regulável  
Mesa ambidiestra regulable



REF. \*DIM.  
DESK21 R0204 70 x 70 x 52-58-64  
DESK21 R0507 70 x 70 x 70-76-82

Mesa ambidextra alta regulável  
Mesa ambidiestra alta regulable



REF. \*DIM.  
DESK21 AR0406 70 x 70 x 89-98-107

Subtampo com Ergos tray  
Bandeja con Ergos tray



REF. \*DIM.  
DESK21 STP 36 x 68 x 9

Mesa dupla  
Mesa doble



REF. \*DIM.  
URI FA 75 x 60 x 61-74  
URI FB 120 x 60 x 61-74

Mesa individual cantilever  
Mesa individual cantilever



REF. \*DIM.  
UNI FA03 75 x 60 x 59  
UNI FA04 75 x 60 x 64  
UNI FA05 75 x 60 x 71  
UNI FA06 75 x 60 x 76

Mesa dupla cantilever  
Mesa doble cantilever



REF. \*DIM.  
UNI FB03 120 x 60 x 59  
UNI FB04 120 x 60 x 64  
UNI FB05 120 x 60 x 71  
UNI FB06 120 x 60 x 76

Mesa de professor  
Mesa de profesor



REF. \*DIM.  
UNI FHA01 120 x 60 x 74

Mesa trapezoidal cantilever  
Mesa trapezoidal cantilever



REF. \*DIM.  
UNI FD04 60/120 x 55 x 61  
UNI FD05 60/120 x 55 x 68  
UNI FD06 60/120 x 55 x 74

## 04 armários armarios

Armário fechado  
Armario cerrado



REF. \*DIM.  
MA 01 100 x 44 x 85  
NA 02 100 x 44 x 160  
MA 03 100 x 44 x 185

Armário aberto  
Armario aberto



REF. \*DIM.  
Mb 01 100 x 44 x 85  
Nb 02 100 x 44 x 160  
Mb 02 100 x 44 x 185

Armário vitrine  
Armario vitrina



REF. \*DIM.  
Nc 02 100 x 44 x 160  
Mc 03 100 x 44 x 185

Armário de desenhos  
Armario de dibujos



REF. \*DIM.  
MI 01 100 x 67 x 85

Armário misto  
Armario mixto



REF. \*DIM.  
Ng 01 100 x 44 x 160

## 05 laboratório laboratorio

Bancada  
Mesada



REF. \*DIM.  
TLBAN 60 x 60 x 72  
(mínimo)

Bancada dupla  
Mesada doble



REF. \*DIM.  
TLBAND 60 x 120 x 72  
(mínimo)

Armário  
Armario



REF. \*DIM.  
TLARM 60 x 60 x 72  
(mínimo)

Prateleira  
Estante



REF. \*DIM.  
TLAL 60 x 30 x 50  
(mínimo)

Techlab mobile  
Techlab mobile



REF. \*DIM.  
BMC 147 x 70 x 92  
BMCT 147 x 70 x 92  
(monitor touch)

Armário com tabuleiros  
Armario con bandejas



REF. \*DIM.  
Nm 03 36 x 44 x 85

Cacifo  
Casillero



REF. \*DIM.  
Ld 03 (9) 100 x 44 x 185  
Ld 04 (12) 101 x 44 x 185  
Ld 02 (15) 102 x 44 x 185

Cacifo com pés  
Casillero con pies



REF. \*DIM.  
Ld 03P (9) 100 x 44 x 185  
Ld 04P (12) 101 x 44 x 185  
Ld 02P (15) 102 x 44 x 185

Armário fechado  
Armario cerrado



REF. \*DIM.  
La 01 100 x 44 x 85  
La 02.1 80 x 44 x 160  
La 02 100 x 44 x 185

Armário de desenhos  
Armario de dibujos



REF. \*DIM.  
Li 01 100 x 44 x 85

Tabuleiro  
Bandeja



REF. \*DIM.  
T2 37,5 x 31 x 15 (12L)

Espumas de acondicionamento  
Espumas de acondicionamiento



REF. \*DIM.  
TE 03 37,5 x 31 x 3

## 06 biblioteca biblioteca

Armário com tabuleiros  
Armario con bandejas



REF. \*DIM.  
Ln 12 107 x 44 x 85

Cacifo aberto  
Casillero abierto



REF. \*DIM.  
LD 13 100 x 44 x 185

Armário aberto  
Armario abierto



REF. \*DIM.  
Lb 01 100 x 44 x 85  
Lb 02.1 80 x 42 x 160  
Lb 02 100 x 43,5 x 185

Armário vestuário  
Armario vestuario



REF. \*DIM.  
Lf 02.1 33 x 44 x 185  
Lf 02.2 67 x 44 x 185  
Lf 02 100 x 44 x 185

Armário vestuário com pés  
Armario vestuario con pies



REF. \*DIM.  
Lf 02.1P 33 x 50 x 193  
Lf 02.2P 60 x 50 x 193  
Lf 02P 90 x 50 x 193

Estante  
Estanteria



REF. \*DIM.  
E.03.01M 92 x 32 x 130  
E.03.03M 92 x 32 x 150  
E.03.05M 92 x 32 x 180

Estante dupla  
Estanteria doble



REF. \*DIM.  
E.03.02M 92 x 64 x 130  
E.03.04M 92 x 64 x 150  
E.03.06M 92 x 64 x 180

Estante expositora  
Estanteria expositora



REF. \*DIM.  
EBP13M 92 x 32 x 130  
EBP15M 92 x 32 x 150  
EBP18M 92 x 32 x 180

Estante  
Estanteria



REF. \*DIM.  
E.03.01PA 92 x 32 x 130  
E.03.03PA 92 x 32 x 150  
E.03.05PA 92 x 32 x 180

Estante dupla  
Estanteria doble



REF. \*DIM.  
E.03.02PA 92 x 64 x 130  
E.03.04PA 92 x 64 x 150  
E.03.06PA 92 x 64 x 180

Estante  
Estanteria



REF. \*DIM.  
Pc 01 103 x 40 x 200

Armário misto  
Armario mixto



REF. \*DIM.  
LG 02 80 x 44 x 160  
LG 03 100 x 44 x 160  
LG 04 100 x 44 x 185

Estante expositora  
Estanteria expositora



REF. \*DIM.  
EBP13PA 92 x 32 x 130  
EBP15PA 92 x 32 x 150  
EBP18PA 92 x 32 x 180

Estante metal simples  
Estanteria metal simple



REF. \*DIM.  
E.03.01.PM 92 x 32 x 130  
E.03.03.PM 92 x 32 x 150  
E.03.05.PM 92 x 32 x 180

Estante metal dupla  
Estanteria metal doble



REF. \*DIM.  
E.03.02PM 92 x 64 x 130  
E.03.04PM 92 x 64 x 150  
E.03.06PM 92 x 64 x 180

Estante metal expositora  
Estanteria metal expositora



REF. \*DIM.  
EBP13PM 92 x 32 x 130  
EBP15PM 92 x 32 x 150  
EBP18PM 92 x 32 x 180

Cadeira em madeira  
Silla en madera



REF. \*DIM.  
Ba 02 26 x 26 x 27  
Ba 03 30 x 28 x 32  
Ba 04 34 x 33 x 36  
Ba 05 38 x 38 x 41  
Ba 06 40 x 40 x 45

## 06 biblioteca biblioteca



|| Cadeira em madeira  
|| Silla en madera



REF.	*DIM.
Ba 02i	26 x 26 x 27
Ba 03i	30 x 28 x 32
Ba 04i	34 x 33 x 36
Ba 05i	38 x 38 x 41
Ba 06i	40 x 40 x 45

|| Contentor de álbuns  
|| Contenedor de álbumes



REF.	*DIM.
03.84M	74 x 68 x 52

|| Mesa de apoio  
|| Mesa de centro



REF.	*DIM.
01.71M	60 x 60 x 40
01.72M	120 x 60 x 40

|| Mesa individual  
|| Mesa individual



REF.	*DIM.
Ga 02	75 x 60 x 47
Ga 03	75 x 60 x 57
Ga 04	75 x 60 x 61
Ga 05	75 x 60 x 68
Ga 06	75 x 60 x 74

|| Mesa dupla  
|| Mesa doble



REF.	*DIM.
Gb 02	120 x 60 x 47
Gb 03	120 x 60 x 57
Gb 04	120 x 60 x 61
Gb 05	120 x 60 x 68
Gb 06	120 x 60 x 74

|| Cadeira Mais Viga com ou sem palmatória  
|| Silla Mais Viga con o sin pala



REF.	LUGARES
MAIS VIGA.(P)2	2
MAIS VIGA.(P)3	3
MAIS VIGA.(P)4	4
MAIS VIGA.(P)5	5

|| Cadeira para auditório  
|| Silla para auditorio



REF.	*DIM.
RETA.AI (inox)	50 x 51 x 44
RETA.AL (lacado)	50 x 51 x 44

|| Cadeira com palmatória  
|| Silla con pala



REF.	*DIM.
RETA.API (inox)	50 x 51 x 44
RETA.APL (lacado)	50 x 51 x 44

|| Cadeira para auditório  
|| Silla para auditorio



REF.	*DIM.
AJS7AI (inox)	57 x 60 x 44
AJS7AL (lacado)	57 x 60 x 44

|| Cadeira com palmatória  
|| Silla con pala



REF.	*DIM.
AJS7API (inox)	57 x 60 x 44
AJS7APL (lacado)	57 x 60 x 44

|| Mesa circular  
|| Mesa circular



REF.	*DIM.
Ge 14	Ø 90 x 61
Ge 15	Ø 90 x 68
Ge 16	Ø 90 x 74

|| Mesa circular  
|| Mesa circular



REF.	*DIM.
Ge 02	Ø 120 x 47
Ge 03	Ø 120 x 57
Ge 04	Ø 120 x 61
Ge 05	Ø 120 x 68
Ge 06	Ø 120 x 74

|| Poltrona  
|| Sillón



REF.	*DIM.
CC 01 NT	65 x 75 x 46
CC 03 NT	120 x 45 x 46

|| Poltrona com braços  
|| Sillón con brazos



REF.	*DIM.
CC 02 NT	65 x 75 x 46
CC 04 NT	120 x 45 x 46

|| Cadeira estofada  
|| Silla tapizada



REF.	*DIM.
CE 00.11M	34 x 36 x 36
CE 00.12M	38 x 40 x 40
CE 00.13M	38 x 40 x 44

## 08 coletividades colectividades

|| Mesa de reuniões  
|| Mesa de reuniones



REF.	*DIM.
ATL.MR.24	160 x 120 x 73
ATL.MR.30	300 x 120 x 73

|| Secretária  
|| Escritorio



REF.	*DIM.
ATL.M	120-200 x 60-80 x 74

|| Alonga  
|| Ala



REF.	*DIM.
ATL.A	80/100 x 60 x 174

|| Bloco rodado  
|| Buc con ruedas



REF.	*DIM.
ABR.2 (2)	43 x 53 x 60
ABR.3 (3)	43 x 53 x 60

|| Secretária pés em "O"  
|| Escritorio pies em "O"



REF.	*DIM.
AR.O	100 x 60 x 72

## 07 auditório auditorio

|| Poltrona  
|| Butaca



REF.	*DIM.
RIA	62 x 48/70 x 94

|| Poltrona com palmatória  
|| Butaca con pala



REF.	*DIM.
RIA.SE	62 x 48/70 x 94

|| Poltrona  
|| Butaca



REF.	*DIM.
CRUZ	62 x 48 x 94

|| Poltrona com palmatória  
|| Butaca con pala



REF.	*DIM.
CRUZ.SE	62 x 48/70 x 94

|| Poltrona  
|| Butaca



REF.	*DIM.
LIS	45 x 16/64 x 78

|| Armário  
|| Armario



REF.	*DIM.
AR.M.7	80/100 x 44 x 72
AR.M.8	80/100 x 44 x 80
AR.M.11	80/100 x 44 x 115
AR.M.15	80/100 x 44 x 150

|| Cadeira simples  
|| Silla simple



REF.	*DIM.
AJS7SI (inox)	49 x 52 x 44
AJS7SL (lacado)	49 x 52 x 44

|| Cadeira com braços  
|| Silla con brazos



REF.	*DIM.
AJS7SBI (inox)	59 x 51 x 44
AJS7SBL (lacado)	59 x 51 x 44

|| Cadeira simples  
|| Silla con brazos



REF.	*DIM.
RETA.SI (inox)	50 x 51 x 44
RETA.SL (lacado)	50 x 51 x 44

|| Secretária (inox / lacado)  
|| Mesa (inox / lacado)



REF.	*DIM.
RETA.M.8	80 x 80 x 73
RETA.M.12	120 x 80 x 73
RETA.M.14	140 x 80 x 73
RETA.M.16	160 x 80 x 73
RETA.M.18	180 x 80 x 73
RETA.M.24	240 x 100 x 73

|| Poltrona  
|| Butaca



REF.	*DIM.
LISII	49 x 45/61 x 92

|| Cadeira para auditório  
|| Silla para auditorio



REF.	*DIM.
ERGOS05 LG	50 x 50 x 43
ERGOS06 LG	50 x 50 x 46
ERGOS07 LG	50 x 50 x 51

|| Carro de transporte  
|| Carro de transporte



REF.	*DIM.
ERGOS.CET	50x 46 x 55

|| Bancada de anfiteatro  
|| Pupitre para anfiteatro



REF.	*DIM.
PES	60 x 61 x 45

|| Bancada com tampo deslizante  
|| Pupitre con encimera deslizante



REF.	*DIM.
PES.TD	60 x 61 x 45

|| Secretária painel frontal (inox / lacado)  
|| Mesa con faldón (inox / lacado)



REF.	*DIM.
RETA.MP.8	80 x 80 x 73
RETA.MP.8	120 x 80 x 73
RETA.MP.8	140 x 80 x 73
RETA.MP.8	160 x 80 x 73
RETA.MP.8	180 x 80 x 73
RETA.MP.8	240 x 100 x 73

|| Bloco de gavetas  
|| Buc con ruedas



REF.	*DIM.
RTBR2 (2)	45 x 57 x 62
RTBR3 (3)	45 x 57 x 62

|| Mesa circular  
|| Mesa circular



REF.	*DIM.
RETA.GE.02.I (inox)	Ø 100 x 73
RETA.GE.02.L (lacado)	Ø 100 x 73

|| Cadeira com braços  
|| Silla con brazos



REF.	*DIM.
RETA.BI (inox)	57 x 51 x 44
RETA.BL (lacado)	57 x 51 x 44

|| Cadeira viga Mais  
|| Silla viga Mais

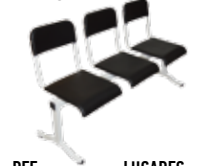

REF.	LUGARES
MAIS VIGA2.AP	2
MAIS VIGA3.AP	3
MAIS VIGA4.AP	4
MAIS VIGA5.AP	5

## 08 coletividades colectividades



### Cadeira Silla



REF.	LUGARES
RETA VIGA2.AP	2
RETA VIGA3.AP	3
RETA VIGA4.AP	4
RETA VIGA5.AP	5

### Trolley Ergos Trolley Ergos



REF.	*DIM.
TSER	38x39x89
TDERG	72x39x89
TTERG	107x39x89

### Estante Ergos Estante Ergos



REF.	*DIM.
ESERG	38x39x185
EDERG	72x39x185
ETERG	107x39x185

### Tabuleiros Ergos Bandejas Ergos



REF.	*DIM.
T1	37,5 x 31 x 7,5 (vol. 5,5L)
T2	37,5 x 31 x 15 (vol. 12L)

### Netboard Easy



REF.	EB-695Wi	EB-670	EB-675Wi	EB-620
EP695Wi				
EPT670				
EP675Wi				
EPT620				

### Netboard Easy



REF.	EB-695Wi	EB-670	EB-675Wi	EB-620
EP695Wi				
EPT670				
EP675Wi				
EPT620				

### Netboard Standard



REF.	EB-670	EB-675Wi	EB-620
SPT670			
SP675Wi			
SPT620			

### Netboard Standard



REF.	EB-695Wi	EB-670	EB-675Wi	EB-620
SMT695Wi				
SMT670				
SMT675Wi				
SMT620				

### Netboard portable



REF.	EB-675Wi
NBPORT1	EB-675Wi + caixa de cabos + caja de cables
NBPORT2	EB-675Wi + prateleira para portátil + bandeja para portátil

## 09 diversos diversos

### Mesa de professor Mesa de profesor



REF.	*DIM.
32.06 097	120 x 60 x 76

### Mesa de professor Mesa de profesor



REF.	*DIM.
Fh 01	120 x 60 x 76

### Quadro branco Pizarra blanca



REF.	*DIM.
QP09	90 x 16 x 120
QP15	150 0x 16 x 120
QP20	200 x 16 x 120
QP25	250 x 16 x 120

### Quadro branco móvel Pizarra blanca móvil



REF.	*DIM.
RB 42	150 x 50 x 200

### Quadro em cortice Tablero de corcho



REF.	*DIM.
QC12	90 x 6 x 120
QC15	120 x 6 x 150
QC20	120 x 6 x 200
QC25	120 x 6 x 250

### Trolley Trolley



REF.	*DIM.
NBPORT TRL	45 x 33 x 58

### Tela de projeção Pantalla de proycción



REF.	*DIM.
NBPORT MT	160 x 100

### Mesa de professor Mesa de profesor



REF.	*DIM.
U11 FH06	120 x 60 x 74

### Mesa dupla Mesa doble



REF.	*DIM.
U11 FB06	120 x 60 x 74

### Mesa dupla com 1 pc Mesa doble con 1 pc



REF.	*DIM.
U11 FX06	120 x 60 x 74

### Armário portas persiana Armario puertas de persiana



REF.	*DIM.
La 06.1	100 x 44 x 85
La 06	100 x 44 x 185

### Armário portas de correr Armario puertas correderas



REF.	*DIM.
La 04.1	100 x 43 x 85
La 04	100 x 43 x 185

### Armário arquivo armario archivo



REF.	*DIM.
La 05	50 x 61 x 132

### Mesa individual Mesa individual



REF.	*DIM.
U11 FA06	75 x 60 x 74

### Netpower altura regulável Netpower altura regulable



REF.	*DIM.
NPC1R	63 x 50 x 60-75
NPC2R	63 x 50 x 75-90

### Netpower altura fixa Netpower altura fija



REF.	*DIM.
NPC1F	63 x 50 x 75
NPC2F	63 x 50 x 90

### Netpower Canvas



REF.	*DIM.
NPCVR	63 x 50 x 75-90
NPCVF	63 x 44 x 90 (fixo/fijo)

### Netpower mobile



REF.	*DIM.
NPMPG AA 04	36H
NPMPG AA 05	41H
NPMPG AA 06	45H

## 10 tecnologia tecnología

### Netboard Easy Led



REF.	
K30NB(M/P)REL55T	55"
K30NB(M/P)REL70T	70"
K30NB(M/P)REL84T	84"

### Netboard Flow Flip Led



REF.	
FFL55	55"
FFL65	65"
FFL70	70"
FFL84	84"

### Netboard Flow



REF.	
F(M/P)L55	55"
F(M/P)L65	65"
F(M/P)L70	70"
F(M/P)L84	84"

### Netboard Flow Flip whiteboard



REF.	EB-675Wi	EB-695 Wi
FFM675Wi		
FFM695Wi		

### Netboard Flow whiteboard



REF.	EB-675Wi	EB-695Wi	EB-670	EB-620
F(M/P)675Wi				
F(M/P)695Wi				
F(M/P)670				
F(M/P)620				

### Powerstation



REF.	*DIM.
ONE PWT	45 x 45 x 85
ONE PWU	45 x 45 x 85

### Armário 40 tablets ou 30 portáteis Armario 40 tablets o 30 portátiles



REF.	*DIM.
NBUS 40	129 x 55 x 118
NBUS 30	129 x 55 x 118

### Armário 32 tablets ou 16 portáteis Armario 32 tablets o 16 portátiles



REF.	*DIM.
NBUS 32	87 x 55 x 139
NBUS 16	87 x 55 x 139

### Armário para 15 tablets Armario para 15 tablets



REF.	*DIM.
NB15	38 x 40 x 185
NB15 USB	38 x 40 x 185

# PROJECTOS PROYECTOS

COLÉGIO DO ROSÁRIO (PORTUGAL). COLEGIO LAR (ESPAÑA).



# PROJECTOS PROYECTOS

UNIVERSIDADE CATÓLICA DA BEIRA (MOÇAMBIQUE). UNIVERSIDADE DE LISBOA (PORTUGAL).



# PROJECTOS PROYECTOS

IGREJA DA SANTÍSSIMA TRINDADE (PORTUGAL). CASA DA MÚSICA DO PORTO (PORTUGAL).



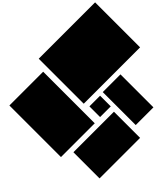

**NAUTILUS**  
INTELLIGENT FURNITURE



# ¡PRESUPUESTO GRATUITO!

*STOCK DISPONIBLE Y ENTREGAS RÁPIDAS*

 **+34 667 911 733**

 **ventas@nautiluscolar.es**

[www.nautiluscolar.es](http://www.nautiluscolar.es)

*Calle Pedrezuela 9-F Pol. Ind. Ventorro del Cano 28925 Alcorcón - Madrid*

PARTNERS:

**Promethean™**

**EPSON**

*acer*

**logitech**

 **ROTRICS**

 **BEEVERYCREATIVE**